

ElectroHeat Subzero



The latest advancement in swimming pool heating, Electroheat Subzero heat pumps extracts latent heat from the surrounding air, intensifies it and transfers it to your swimming pool.

Electroheat Subzero heat pumps will heat your pool even when the ambient air temperature is below freezing point (0°C).

- Energy efficient heating
- Temperature management & self-diagnosis
- Automatic hot gas de-icing for cold climates
- High density titanium heat exchanger
- Weather proof cabinet



Energy efficient heating

A swimming pool is a major financial investment. Getting the most out of your pool, means keeping the pool at a swimmable temperature for the maximum number of hours in each day and the maximum number of days in each year.

A heat pump will economically keep your pool warm 24 hours a day.

Compared to gas and electric heaters, Electroheat Subzero uses just a fraction of the energy to generate the same amount of heat and unlike solar heating; there is no reliance on the sun as the latent heat in the air is used.

How the Electroheat works

Electroheat Subzero uses refrigeration technology to extract heat from the surrounding air and transfers it to the swimming pool.

Step 1 Heat extraction

The fan circulates air through the evaporator air coil that acts as a heat collector. The liquid refrigerant in the evaporator air coil absorbs the available heat from the ambient air.

Step 2 Heat Intensification

The compressor then receives the warmed refrigerant and intensifies the heat. The intensely hot refrigerant is then pumped into the heat exchanger.

Step 3 Heat Transfer

The heat from the hot refrigerant flowing inside the heat exchanger is then transferred to the pool water.

Step 4 Recycle

The refrigerant restarts the process and flows through the evaporator air coil to collect heat once again.

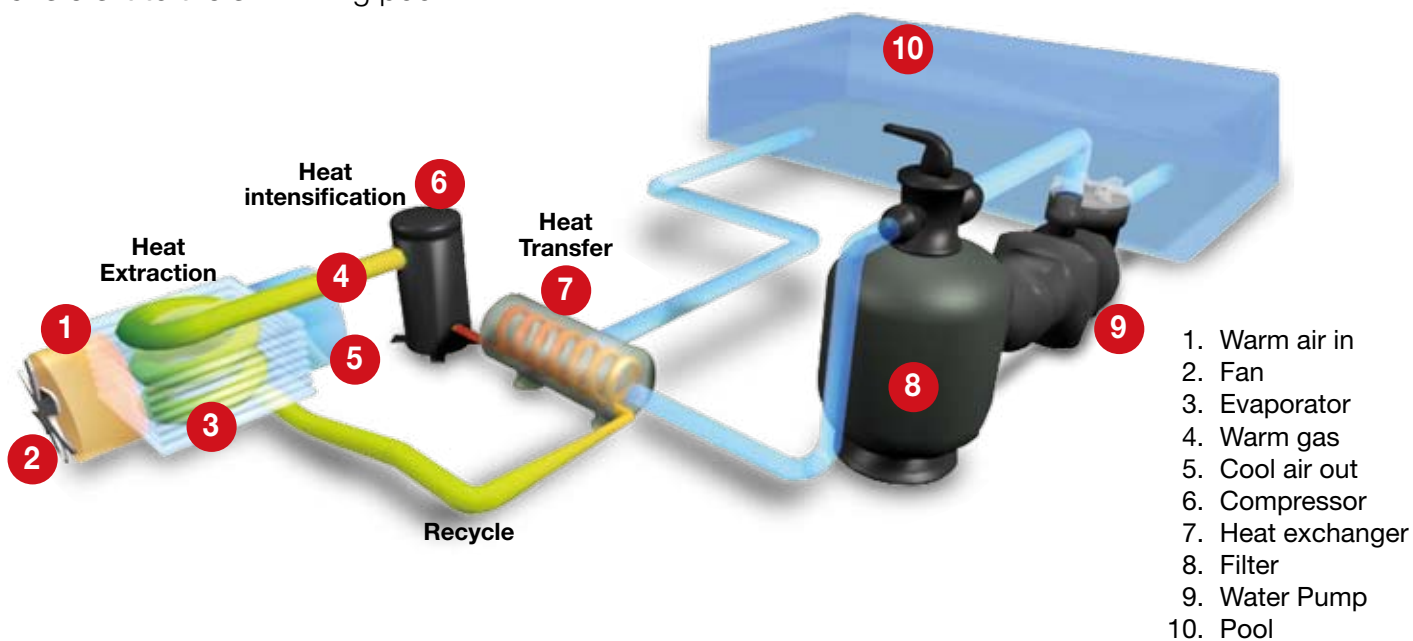



Cost effective heating

Heat pumps only require energy to operate a compressor and a fan motor, using low amperage in the process.

The Electroheat produces over 4 times more heat energy than the electrical power it consumes.

For every 1kW of electricity consumed, Electroheat can produce over 4 kW of heat.

Save up to 80% over propane gas, 50% over natural gas and 500% over electric heaters.

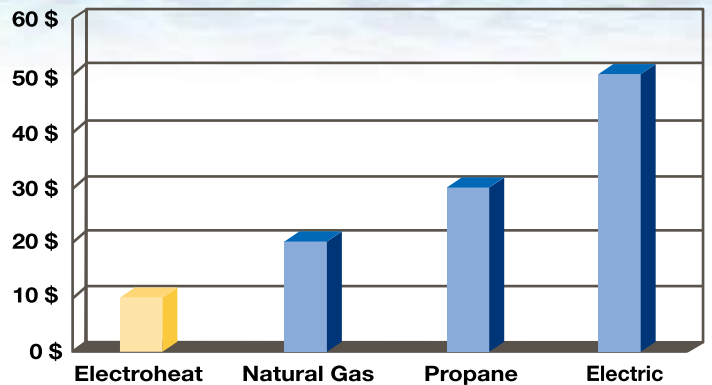

Electroheat Subzero

Incorporating the latest smart technology and long lasting components, Electroheat Subzero is designed and built for trouble free operation.

Simply program your desired pool water temperature and let the Electroheat Subzero do the rest.





Temperature management & self-diagnosis

Electroheat Subzero's LED control panel provides a continuous digital pool temperature display and incorporates a self diagnosis system. In the event of a problem, the control panel will display diagnostic error codes.

The control panel also features an option to switch from POOL to SPA mode automatically via an external water pressure switch or manually via a remote control.



Inbuilt protection devices

The integrity and performance of your pool heater and its components are protected by built-in safety devices

- **Auto defrost control** to eliminate frost on the evaporator.
- **Auto flow switch** to shutdown the system in the event of no water flow.
- **High / Low pressure refrigerant auto reset** to shutdown the system in the event of low or high refrigerant pressure
- **Compressor protection** via a time delay to allow the refrigerant to equalise before the compressor starts/restarts.



Titanium heat exchanger

Titanium heat exchangers have a longer life expectancy than standard copper heat exchangers. Titanium offers total protection against erosion and corrosion, it is resistant to: chlorinated water, ozone, iodine, Baquacil, bromine and salt water.

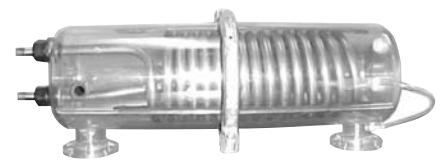

Powerful heat transfer

The exclusive design of the Electroheat Subzero's heat exchanger creates an unmatched and powerful heat transfer source. Surface area contact with the heat exchanger is maximised by circulating water through its condenser tubes.

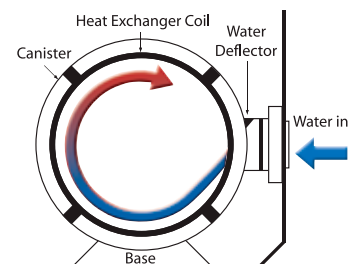

Efficient scroll compressor

Electroheat Subzero's are powered by a Scroll compressor, the most powerful, energy efficient compressors on the market and most importantly they are also the quietest.





Extra large evaporator area

Electroheat Subzero has an extra large evaporator allowing it to extract more heat from the outside air maximising the heat pump's performance and efficiency.



Weather proof cabinet

The Electroheat Subzero's cabinet is constructed of heavy-duty UV-resistant proof ABS body panels that are impervious to rust, corrosion and deterioration.



ElectroHeat
Subzero





Electroheat Subzero heating

Electroheat Subzero features an automatic hot gas de-icing function, enabling it to continue heating your pool even when the air temperature drops below zero.

If any ice forms on the evaporator, the Electroheat Subzero's pipe configuration is temporarily reconfigured via a reversing valve to allow hot gas to melt the ice, the Electroheat Subzero then reverts back to heating your pool.

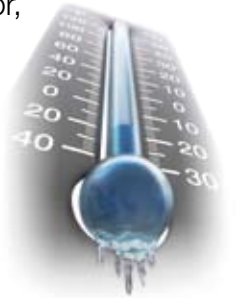



Quick and easy installation

Simply connect the pool return line to and from the heat pump and connect the power source.

Please note: Electroheat Subzero is designed for outdoor installation and should not be installed in enclosed areas such as a shed or garage, unless mechanical ventilation is provided to ensure adequate air exchange for proper operation.

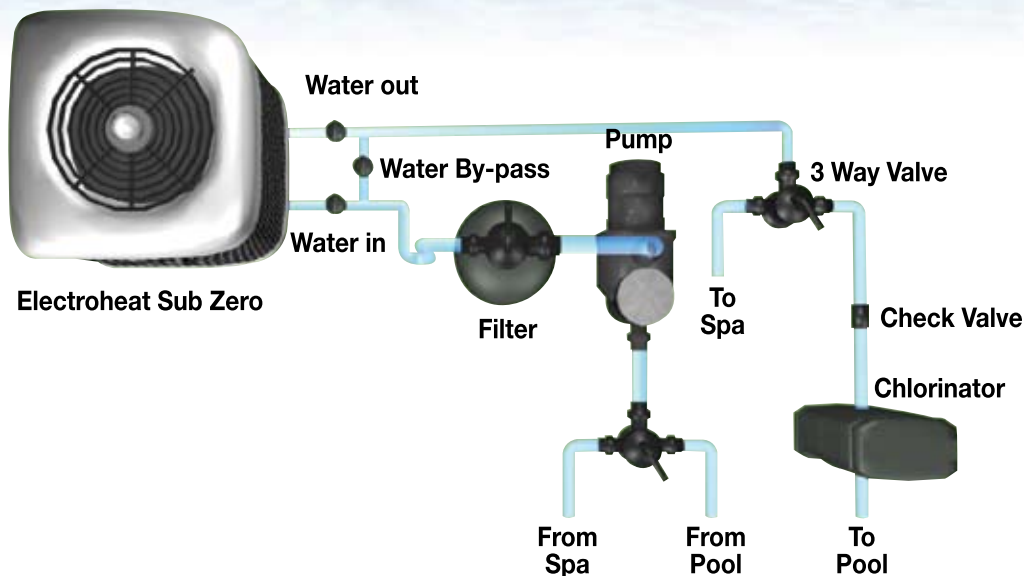

5 year warranty

Electroheat Subzero is covered by a 5 (2+3) year warranty for residential installations and a 1 year warranty for commercial installations.





Frequently asked questions

Should I use a pool cover?

The most effective way to prevent heat loss is to install a pool cover. An un-blanketed pool loses 2-3 times more heat than a blanketed pool. Pool covers virtually eliminate evaporation and reduce heat loss by insulating the surface of the pool, greatly reducing pool heating costs. As with all pool heaters, it would be advisable to use a pool cover at night, and when the pool is not in use.

What is the minimum ambient operating temperature?

The Subzero heat pump will actually operate down to an ambient air temperature of 0°C, but with minimal heat output. Therefore we recommend that the minimum operating temperature should be 5°C.

What is the best location for the Electroheat Subzero?

The location of the Electroheat Subzero is very important in keeping installation costs to a minimum, while providing for maximum efficiency of operation as well as allowing adequate service and maintenance access.

The unit should be located as close as practically possible to the existing pool pump and filter to minimise water piping. The use of 90 degree bends and short radius elbows in the water piping should be kept to a minimum. The longer the distance from the pool, the higher the heat loss from the piping.

Can the Electroheat Subzero be enclosed?

The Electroheat Subzero is designed for outdoor installation and should not be installed in totally enclosed areas such as a shed, garage, etc., unless mechanical ventilation is provided to ensure adequate air exchange for proper operation. Re-circulation of cold discharged air back into the evaporator coil will greatly reduce unit's heating capacity and efficiency.





What is the Electroheat Subzero's performance dependent on?

Electro Heat's performance will fluctuate depending on water and weather temperatures. 5 important factors determine the performance of Electroheat Subzero:

1. Size of the pool.
2. The desired temperature of the pool
3. Ambient air temperature - the warmer the air, the better the performance
4. The presence of a pool cover
5. The size of the heater

What is the Electroheat Subzero's heater running time?

Most units should be sized to operate during the pool filtering cycle time of 8 - 12 hours daily, providing a steady flow of heated water. On warmer days the heater will run less because the heat loss will be less.

Electroheat Subzero heat pumps have a lower heating capacity on a BTU/hr basis compared to fossil fuel based pool heaters such as gas heaters. Therefore, Electroheat Subzero heat pumps require longer operation to accomplish the desired temperature.

Between 10°C to 18°C, it will increase your water temperature by 3°C to 5.5°C a day. Over 21°C you should obtain an increase up to 0.8°C a hour and over 26°C up to 1.1°C an hour depending on the size of the pool, the size of the heat pump, the water temperature, and the ambient air temperature at the moment of operation.

Even though the Electroheat Subzero may require longer operation, it will still heat the pool far more economically.

How does Electroheat Subzero compare with solar heating and gas heating?

Solar

- Fuelled by the power of the sun, solar heating systems are a low-cost, method of heating up your pool water.
- As solar heating is reliant on the sun, they are best used to extend the swimming season.
- Virtually no operating costs, just the cost of electricity to pump the pool water through the solar absorber on the roof.

Gas heaters

- Gas heaters are fastest method for heating your pool, providing a comfortable temperature for swimming on demand. Gas is best for heating pools or spas for short periods of time.
- Gas heaters can easily maintain any desired temperature regardless of the weather.
- Gas heaters are effective, but expensive to operate.

Heat pumps

- Heat pumps may not heat up the swimming pool as fast as gas heaters, but they are a more energy efficient.
- Heat pumps require a small amount of electricity; its heat energy source is extracted from the ambient air.



Sizing chart to heat your pool to 28 °C

Pool Size m	Surface Area m2	Litres	Model		
			Regional average daytime temperatures Between September to April		
			Over 20°C	18°C to 23°C	10°C to 15°C
3x7	21	Up to 29400	55	55	75
4x7	28	Up to 39200	55	75	100
4x8	32	Up to 44800	75	75	100
4x9	36	Up to 50400	75	100	100
5x9	45	Up to 63000	100	100	See Dealer
5x10	50	Up to 70000	100	See Dealer	See Dealer
5x11	55	Up to 75000	100	See Dealer	See Dealer

Please note: Heat pump sizing is influenced by ambient temperature, humidity, presence of a pool cover, nightly temperatures, pool location, wind factor, water features and hours of operation.

Technical Specifications

Models	ElectroHeat Subzero 55	ElectroHeat Subzero 75		ElectroHeat Subzero 100
Nominal Heating Capacity btu *	55,000 BTU	75,000 BTU		100,000 BTU
Power Output (Kw)	16	22		31
Supply Voltage (VAC)	240	240	415	415
Supply Voltage Phase	1 phase	1 phase	3 Phases	3 Phases
Power consumption (kW/h)	4	5.4	5.3	7.2
Unit Running Amperage	16.9	22.4	10.1/ Phase	10.4 /Phase
Fan Full Load Amp (FLA)	1.0	1.0		1.0
Min / Max Breaker or Fuse (AMP)	30-40	40-50	25	25
Noise Level @ 3m in dB	60	61	62	62
Min./Max. Air Inlet Temperature (C)	0 - 40	0 - 40	0 - 40	0 - 40

* Heating capacity is dependant upon water temperature , ambient temperature and humidity

Water Flow & Plumbing Characteristics

Water Bypass Type	Ext. Field Install	Ext. Field Install	Ext. Field Install	Ext. Field Install
Min./Max. Water Flow Rate (LPM)	180-225	180-225	170-200	180-225
Min./Max. Water Inlet Temperature (Degrees C)	12-40	12-40	12-40	12-40
Plumbing Connection Size (Inch. / mm)	1-1/2" / 40mm	1-1/2" / 40mm	1-1/2" / 40mm	1-1/2" / 40mm





Top View

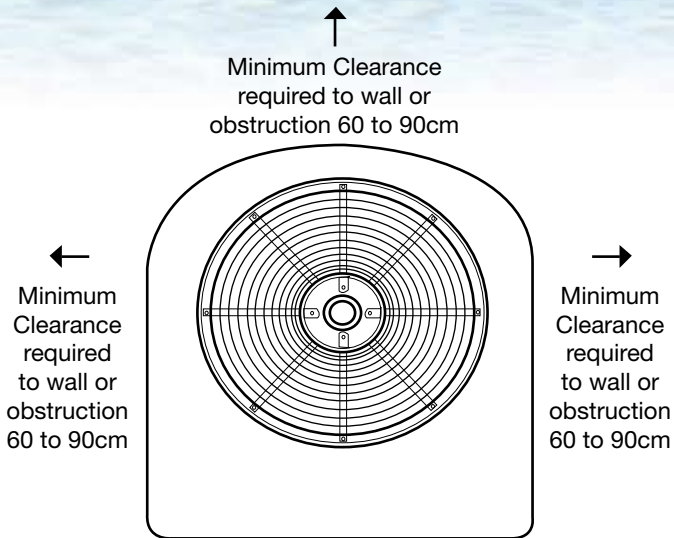

Minimum Clearance required to wall or obstruction 60cm

Front View

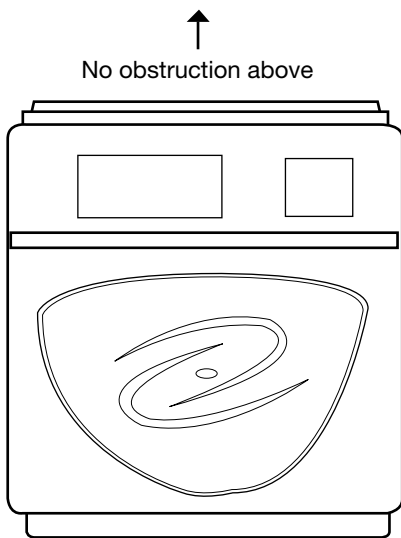

Dimensions

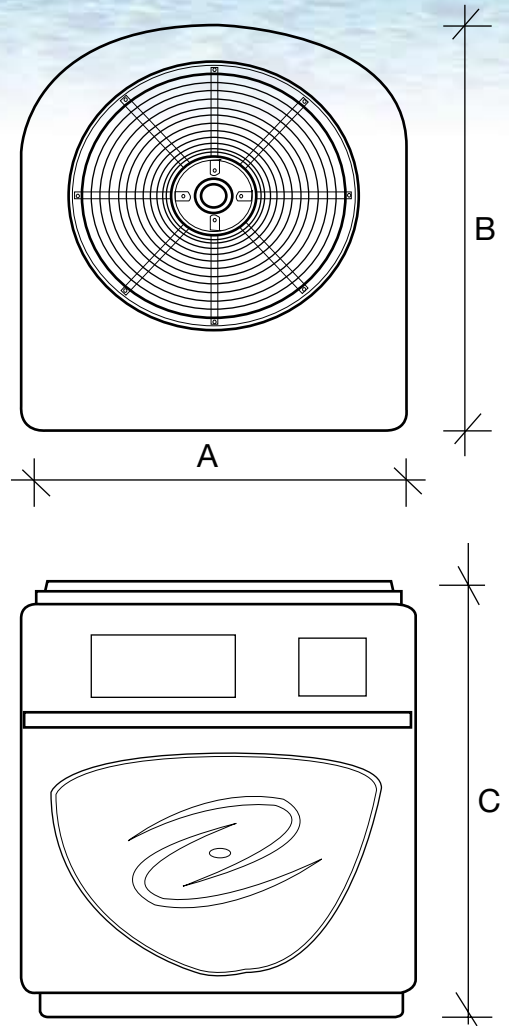

	SubZero 55	SubZero 75	SubZero 100
A	750mm	890mm	890mm
B	890mm	940mm	940mm
C	870mm	990mm	990mm

Weight

SubZero 55	SubZero 75	SubZero 100
90kg	108kg	118kg



Established since 1981, Waterco is an Australian public listed company involved in the manufacture and distribution of:

- Swimming pool/spa equipment and chemicals
- Domestic water filters, softeners and purifiers
- Commercial and Industrial water treatment equipment.

The company's advanced fibreglass winding and pioneering plastic moulding techniques have delivered premium quality products to over 40 countries via its branches operating in Australia, New Zealand, Malaysia, Singapore, China, the United Kingdom, United States of America, Canada and Indonesia.



OFFICES - AUSTRALIA

NSW - Sydney (Head Office)
Tel: +61 2 9898 8600
QLD - Brisbane
Tel: +61 7 3299 9900
VIC/TAS - Melbourne
Tel: +61 3 9764 1211
WA - Perth
Tel: +61 8 9273 1900
SA/NT - Adelaide
Tel: +61 8 8244 6000
ACT Distribution
Tel: +61 2 6280 6476

OFFICES - OVERSEAS

Waterco (Europe) Limited
Sittingbourne, Kent, UK
Tel: +44 (0) 1795 521 733
Waterco (USA) Inc
Augusta, Georgia, USA
Tel: +1 706 793 7291
Waterco Canada
St Hyacinthe, Quebec, Canada
Tel: +1 450 796 1421
Waterco (NZ) Limited
Auckland, New Zealand
Tel: +64 9 525 7570

Waterco (C) Limited
Guangzhou, China
Tel: +86 20 3222 2180

Waterco (Far East) Sdn Bhd
Selangor, Malaysia
Tel: +60 3 6145 6000

PT Waterco Indonesia
Jakarta, Indonesia
Tel: +62 21 4585 1481

Waterco Singapore Intl Pte Ltd
Nehsons Building, Singapore
Tel: +65 6344 2378

