

WATERCO POOL HEAT PUMP



User and Care Guide Manual

WARNING

This equipment must be installed and serviced by a qualified technician. Improper installation can create electrical hazards which could result in property damage, serious injury or death. Improper installation will void the warranty.



Notice to Installer

This manual contains important information about the installation, operation and safe use of this product. Once the product has been installed **this manual must be given to the owner/operator of this equipment.**

Table of Contents

| | | | |
|--|----|---|----|
| A NOTE TO YOU | 02 | How to Program The Multi Function | 18 |
| GENERAL SAFETY | 03 | Electronic Control Timer to Control Your | |
| INSTRUCTIONS | | Pool Pump Filtration | |
| INSTALLATION INSTRUCTIONS | 05 | How to Program The Timer | 18 |
| Location | 05 | How to Stop The Timer | 18 |
| Water Piping | 07 | Electrical connection required to use | 18 |
| Plumbing Diagram | 07 | the integrated pool water pump timer | |
| Electrical | 08 | of your pool heat pump | |
| Electrical Connection | 08 | Protection Devices | 20 |
| Bonding | 09 | Adjustment of The Bypass Valves | 20 |
| Bonding Diagram | 09 | | |
| OPERATION OF YOUR POOL HEAT PUMP | 10 | MAINTENANCE OF YOUR POOL HEAT PUMP - | 21 |
| Initial Heating | 10 | Winterizing | 21 |
| Pool Heat Pump Running Time | 10 | TROUBLESHOOTING | 22 |
| Pool Solar Blanket | 11 | Nothing Is Working and The | 22 |
| Defrost Cycle | 11 | Electronic Control Does Not Operate | |
| Electronic Control with Diagnostics | 11 | Nothing Is Working But The Electronic | 23 |
| and Reversible (XLR) Electronic | | Control Temperature Displays Digits | |
| Control with Diagnostics | | or a Code | |
| To Start The Pool Heat Pump | 12 | Fan Doesn't Work (The Fan Blades | 23 |
| To Stop The Pool Heat Pump | 12 | Are Not Moving) | |
| To Check and Adjust Temperature Settings - | 12 | Fan Blades Turn, But Compressor | 23 |
| Specific Functioning of Your Reversible | 13 | Is Not Functioning | |
| Electronic Control with Diagnostics | | Compressor Starts and Stops | 24 |
| Temperature Calibration | 14 | There Is Water Around The Pool Heat Pump- | 24 |
| Operation of Multi Function Electronic | 15 | Pool Heat Pump Has Ice Formed | 25 |
| Control Panel | | On The Evaporator Coil | |
| To Start the Pool Heat Pump | 15 | Pool Heat Pump Is Functioning, But Does -- | 26 |
| To Stop the Pool Heat Pump | 15 | Not Reach The Desired Temperature Setting | |
| To Raise or Lower Desired Water | 16 | Analysis Chart | 27 |
| Temperature | | Circuit Breaker Trips | 27 |
| To Change Display from Farenheit | 16 | The Pool Heat Pump Is Noisy | 28 |
| to Celcius | | The Temperature Shown On Pool Heat | 28 |
| Defrost for Electroheat Subzero | 16 | Pump Is Not The Same That Is | |
| Electrical connection of an automatic | 17 | Shown By The Pool Thermometer | |
| mode for the pool and spa (Smart Energy | | Service Analyser Codes | 29 |
| model only) | | WARRANTY | 33 |

A NOTE TO YOU

Congratulations!

You have made an excellent choice! The Waterco pool heat pump will give you unique comfort at low-price.

Using the latest technology in heat capture, the Waterco pool heat pump converts the energy released by the sun and transfers it efficiently to your swimming pool.

During certain periods it may be necessary to operate your pool heat pump continuously however this should not be of concern as your Waterco pool heat pump can heat up your pool 80% more economically than the fossil fuel heating or heaters with electric elements. Waterco pool heat pumps are designed specifically to heat up your swimming pool economically.

To appreciate the benefits that the product will bring you, make sure to operate the unit when the atmospheric conditions specified in this document are present in addition of using a solar blanket to minimize heat loss. Pools not covered with a solar blanket lose 2 to 3 times more heat, regardless of types of heating!

Record your model's information.

Keep this manual and your original proof of purchase receipt for warranty and future reference.

On the base of your pool heat pump is a name plate which contains information such as model number, serial number and electrical information.

Please write these down below and have them handy in case of a service call request.

Model Number _____

Serial Number _____

Purchase Date _____

Dealer Name _____

Dealer Address _____

Dealer Phone _____

To find detailed product information, the location of the nearest dealer or to register your pool heat pump please visit our website www.waterco.com and select your location.

GENERAL SAFETY INSTRUCTIONS

We have provided important safety messages in this manual and on your pool heat pump. Always read and obey all safety messages.

 **WARNING**

This is the safety alert symbol.

This symbol alerts you to hazards that can kill or hurt you and others.

 **VITAL**

This is a very important label.

This symbol alerts you of instructions that **MUST** be followed properly in order to ensure that your warranty will not be voided.

 **IMPORTANT**

These are instructions that must be respected in order to protect the user's health and to ensure that your warranty will not be voided.

GENERAL SAFETY INSTRUCTIONS

WARNING

All electrical connections must be carried out by a qualified electrician, according to the local electrical codes. Always cut off the unit's main power whenever the access panel is open or removed. It is strongly recommended that the pool heat pump is installed outdoors (unless approved by the manufacturer), while respecting the minimal clearances needed for proper operation and heating. Please refer to "Location" on the following page

IMPORTANT

Proper pool chemistry is vital to the longevity of your pool heat pump. Pay particular attention to the **total alkalinity** and **total dissolved solids**. It is highly recommended that you have your pool chemistry checked often by an outside independent pool store. Your pool water chemistry must be maintained at all times as shown in the table below to prevent damage to your pool heat pump.

USAGE OF CHEMICAL PRODUCTS

Never add liquid chlorine, granular chlorine, or slow dissolving tablets/ pucks into the skimmer basket. This high concentration of chemicals should be avoided.

Water quality standards that must be strictly adhered to*:

| DESCRIPTION | NORMAL RANGE* | VERIFY |
|-------------------------------|----------------------------------|-----------------|
| PH Level | 7.4 to 7.8 | 1 per week |
| Chlorine Concentration | 1.0 to 4.0 PPM | 1 per 2-3 days |
| Total Alkalinity | 100 to 120 PPM | 1 per 2-3 weeks |
| Total Dissolved Solids | below 1800 PPM <i>Reg. Pool</i> | 1 per month |
| | below 3500 PPM <i>Salt. Pool</i> | 1 per month |
| Calcium Hardness | 200 to 300 PPM | 1 per month |

* Warranty can be voided if not maintained within these ranges.

VITAL

MAKE SURE THE INSTALLATION WAS CARRIED OUT ACCORDING TO THE INSTRUCTIONS OF THIS MANUAL. SEE "INSTALLATION" SECTION.

MAKE SURE YOUR POOL HEAT PUMP WAS PROPERLY GROUNDED AND BONDED. SEE "BONDING" AND "BONDING DIAGRAM" SECTIONS.

BEFORE ASKING FOR ASSISTANCE OR SERVICE, PLEASE READ CAREFULLY THE SECTIONS ON "TROUBLESHOOTING " AND "WARRANTY".

GENERAL SAFETY INSTRUCTIONS

DO NOT DEPRIVE YOUR POOL HEAT PUMP OF WATER FLOW FOR MORE THAN 24 HOURS WITHOUT DRAINING IT. Make sure you leave the bypass valves as shown in Figure 1.

At the end of each season, when the pool heat pump is no longer in use, and proper pool water chemistry is not maintained, it should be disconnected from the water line and drained to prevent any possible corrosion or damage to the pool heat pump. Refer to Figure 1 below or interizing procedure (page 21).

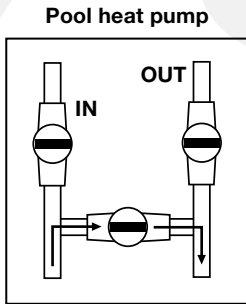

When your valves position are as shown on Figure 1, the water is bypassing the pool heat pump.

Figure 1

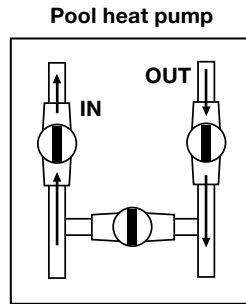

When your valves position are as shown on Figure 2, the water is going through the pool heat pump.

Figure 2

The valves shown above may be different to the ones installed on your system. Please ensure you understand how your bypass valve operates.

INSTALLATION INSTRUCTIONS

Location

In order to gain maximum efficiency please follow the instructions when deciding where to position your pool heat pump. It is also important to allow clearances for future service and maintenance procedures.

The unit is designed for outdoor installation and should not be installed in a totally enclosed area such as a shed, garage, etc., unless ventilation is provided to ensure adequate air exchange for proper operation. Re-circulation of cold discharged air back into the evaporator coil will greatly reduce unit's heating capacity and efficiency.

INSTALLATION INSTRUCTIONS

Location

The unit should be located as close as practically possible to the existing pool pump and filter to minimize water piping. The use of 90 degree bends and short radius elbows in the water piping should be kept to a minimum.

Mount the unit on a sturdy base, preferably a concrete slab or blocks. The base should be completely isolated from the building foundation or wall to prevent the possibility of sound or vibration transmission into the building. The size of the base should not be less than the base of the pool heat pump.

IMPORTANT

Your pool heat pump will accumulate condensed water (approx. 1 to 1.5 gallon or 4 to 6 litres per hour), therefore causing water to drain out of the unit base. In order to avoid water accumulation, you may use decorative rocks around the concrete slab or a basin under the unit. (Please note this is a normal characteristic of a pool heat pump and not a service or warranty issue.)

Air is pulled through the evaporator coil and discharged through the top or front grill. Clearances should be allowed in front and around the unit for unrestricted air discharge and service access. See Figure 1 and Figure 2.

Re-circulation of cold discharged air back into the evaporator coil will greatly reduce unit's heating capacity and efficiency.

Top Discharge Models

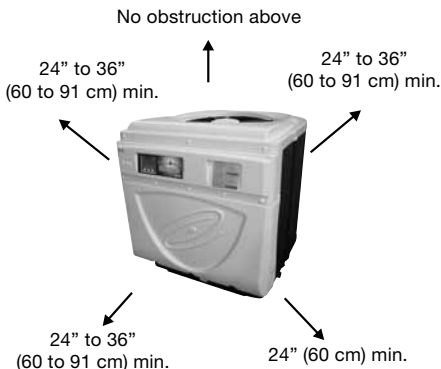

Figure 1

Side Discharge Models

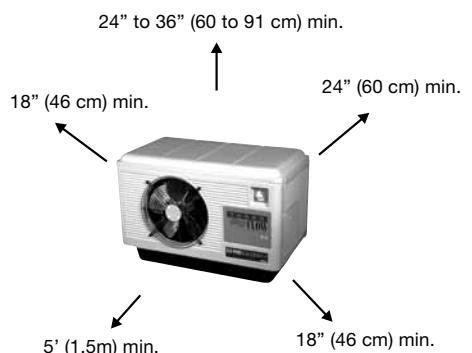

Figure 2

INSTALLATION INSTRUCTIONS

Water Piping

The following piping sequence must be followed without exception: 1-pool pump 2-filter 3-pool heat pump 4 chlorinator (when installed). Rigid PVC piping is recommended, all joints should be glued with PVC glue. If rigid PVC is not available, you can use soft or flexible piping with stainless steel clamps. When the piping installation is complete, operate the pool pump and check the system for leaks. Then check the filter pressure gauge to see that excessive pump head pressure is not indicated. *NOTE: Units are designed to operate with a minimum water circulation of 132 LPM/35 GPM.*

NOTE: A bypass kit is strongly recommended and should be installed for adjustment of water flow and ease of service.

Plumbing Diagram

VITAL

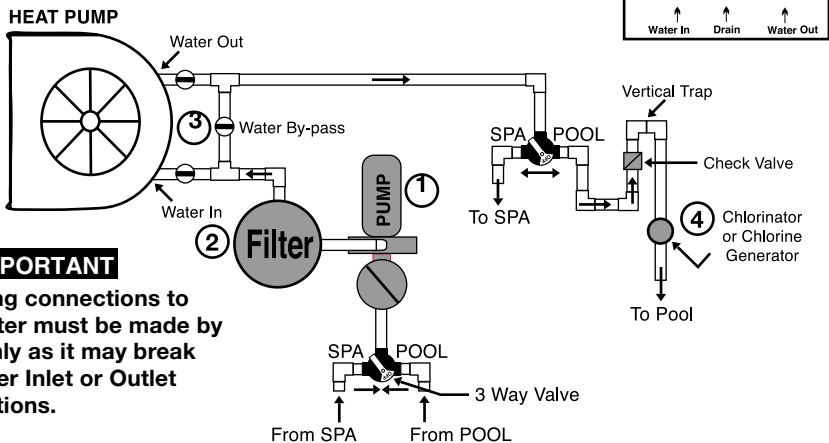

IMPORTANT

Plumbing connections to the heater must be made by hand only as it may break the water Inlet or Outlet connections.

1. Either a 1/3 pound check valve or a loop **MUST** be installed between the pool heat pump and any automatic chlorinator to prevent highly chlorine concentrated water from flowing back to the pool heat pump when the pool pump is not running.
2. Units which are located below the water level of the swimming pool may require the pressure switch to be adjusted. This can be checked by the following method:
 - i) switch on the water pump and pool heat pump.
 - ii) while the pool heat pump is running switch "OFF" the water pump. If the pool heat pump shuts down automatically no further action is required.

If the heat pump continues to run you will need to have a qualified technician adjust the water pressure switch. For further information please, contact Waterco.

INSTALLATION INSTRUCTIONS



Electrical

To ensure your safety and ensure the adequate functioning of your pool heat pump, all electrical **work should be performed by a fully qualified and licensed electrician in accordance with local electrical codes.**

An adequate circuit breaker and copper wiring must be used. This information is available on the name plate of the pool heat pump. It may be necessary to install a ground circuit breaker.

⚠ WARNING THE POOL HEAT PUMP MUST BE DISCONNECTED BEFORE OPENING THE ACCESS PANEL.

Electrical Connection

Standard 60 Hz power supply : 208/240 v - 60Hz-1 phase

Standard 50 Hz power supply : 208/240 v - 50Hz-1 phase

3 phase power supply : 200/230 v - 50/60 Hz - 3 phase
380/420 v - 50/60 Hz - 3 phase

Breaker Size

Please consult name plate on the base or the side of your pool heat pump for running amperage and required breaker size.

Electrical Wire Size

Please consult a qualified and licensed electrician.



The power cable ground must be connected to the electrical panel and to the ground lug of the pool heat pump. An improper installation may be a potential cause of fire, electrical shock or injury.

INSTALLATION INSTRUCTIONS

Bonding

⚠ VITAL

Because all metals have different electrical potentials, **ALL metal and electrical components of the pool system MUST be bonded together.** This includes the metal framework of the pool, the light, the pump, the filter (if metal), the pool heat pump, any automatic chlorine generator, and any other metal or electrical equipment bonded to your pool.

On some older pools, this substructure bond wire may not exist. In these cases, a 3 - 4 foot solid copper rod must be driven into the ground near equipment; all electric and metal components must be bonded to each other, and to the copper rod. Warranty will be voided if system is not properly bonded.

CAUTION: It is recommended when using automatic chlorinators, to ensure that they are properly installed and bonded. Some of these systems may leak stray voltage and currents into the water causing severe electrolysis. This dramatically shortens the life of the pool heat pump and will void the warranty.

NOTE: Bonding to pool pump is not required to above ground pool pumps but all other equipment must be bonded.

Bonding Diagram

⚠ VITAL

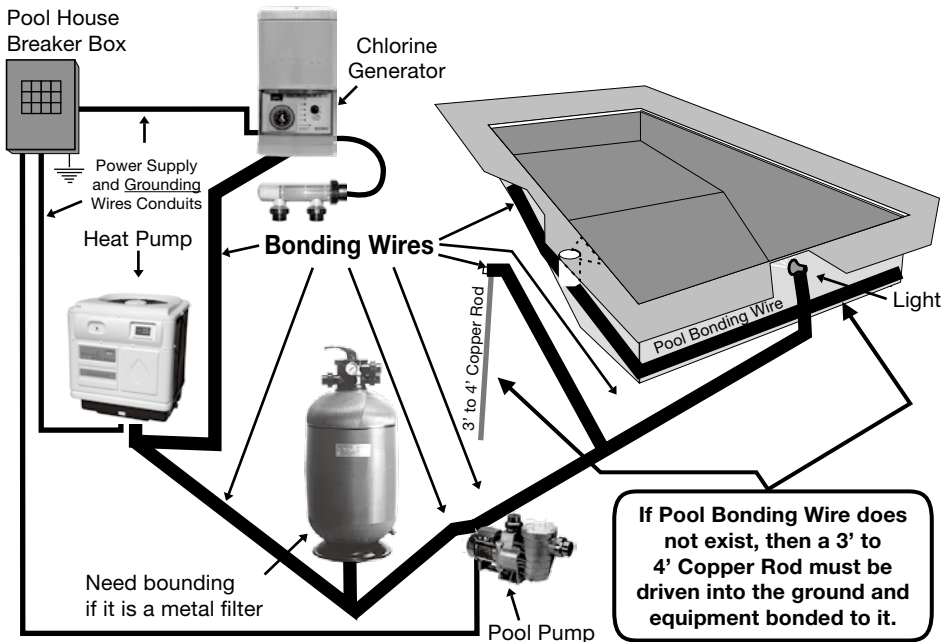

OPERATION OF YOUR POOL HEAT PUMP

Initial Heating

Atmospheric conditions as well as the pool water temperature should not be below the minimum operating temperatures as stated below in order to obtain efficiency and avoid codes from appearing on the electronic control temperature display ; these codes are not generally a problem with the pool heat pump at these conditions and is not covered by the warranty.

If temperatures are below the minimum temperatures listed the pool heat pump should not be operated and must be switched off.

For Electroheat SubZero and Reversible (XLR) units, they will automatically stop without human intervention.

| Model | Atmospheric conditions must be above | Pool water temperature must be above |
|---------------------|---|---|
| Electroheat SubZero | 32°F (0°C) | 50°F (10°C) |
| Reversible (XLR) | 43°F (6°C) | 65°F (18°C) |
| All others | 52°F (11°C) | 65°F (18°C) |

The speed of heating is dependent upon five basic factors:

1. Size of the pool.
2. How many degrees the water is to be heated.
3. Ambient air temperature - the warmer the air, the less time required to heat.
4. Use of a solar blanket .
5. The size of the pool heat pump.

To achieve initial heating, your pool heat pump and the pool pump may work up to 24 hours per day until desired temperature is achieved. The initial heating time may vary depending upon the above five factors. After initial heating, operating time may be reduced to match daily heat loss.

Pool Heat Pump Running Time

Most units should be sized to operate during the pool filtering cycle time of 8-12 hours daily, providing an even, steady flow of warm water. On warmer days the pool heat pump will run less because the heat loss will be less. Pool heat pumps are able to operate 24 hours per day when necessary.

Pool Solar Blanket

A pool solar blanket should be used whenever possible. Blankets minimize heat loss and conserve heat in your pool. Un-blanketed pool lose 2-3 times more heat than a blanketed pool

Defrost Cycle

When any of the following conditions occur the electronic control of your unit will activate a defrost mode until all frost from the evaporator has melted. Condensation of water on the evaporator coil tends to frost up quicker when the following occur.

1. When atmospheric conditions are as stated above;
2. When the evaporator is dirty;
3. When installation clearances are not respected.

Defrost is activated for between 3 to 20 minutes.

Electronic control with diagnostics and Reversible (XLR) electronic control with diagnostics

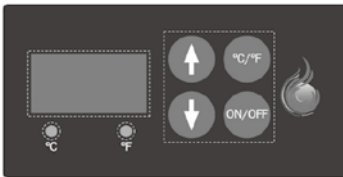

**Electronic Control
with diagnostics**

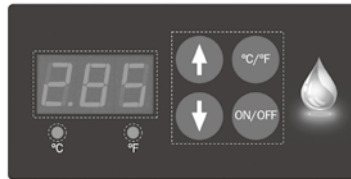

**Reversible (XLR) electronic control
with diagnostics**

To Start The Pool Heat Pump

Press the button on the electronic control ON/OFF to start the pool heat pump. The temperature display will show the pool water temperature flowing in your pool heat pump and the fan motor starts (fan blade turns) but the compressor does not start.

The temperature display flashes until the compressor starts and when the timer will complete its cycle of 3 to 5 minutes. After 5 minutes, the compressor starts and the temperature on the display stops flashing.

You can now program the desired temperature for the pool water.

To Stop The Pool Heat Pump

The pool heat pump can be stopped by pressing the **ON/OFF** button once.

To Check and Adjust Temperature Settings

To program the desired water temperature, press BOTH the UP and DOWN arrow keys at the same time until the temperature degree displays change degree, then release them.

Press the UP arrow or DOWN arrow to program the desired temperature. The temperature setting will automatically flash and will be saved. The display temperature will be revert back to the pool water temperature when all keys have remained untouched for 5 seconds.

To change the temperature display from Fahrenheit (°F) to Celcius (°C). Press, the button °C/°F. The led below the °F or °C will be lit to indicate the current selection.

Note: The pool heat pump will cut out at once when the programmed temperature has been reached.

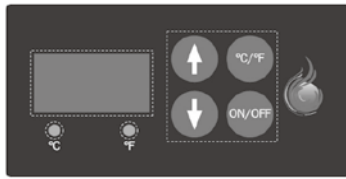

**Electronic Control
with diagnostics**

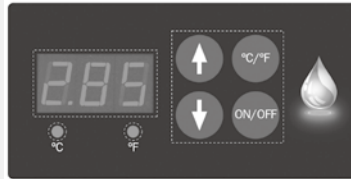

**Reversible (XLR) electronic control
with diagnostics**

In addition to controlling the temperature of the water, this electronic control informs you on the operation of your pool heat pump or any faults that may arise by displaying codes on the temperature display.

When the unit is in defrost mode the code “**DEF**” is displayed on the temperature display. This under normal conditions is not considered to be a fault.

Specific functioning of your reversible electronic control with diagnostics

During the defrost cycle, the fan motor stops working and the hot gas is injected into the evaporator to melt the frost. However, when the unit makes 4 cycles (heating and defrost) consecutive within 1-hour, the unit goes into protection mode to avoid inefficient use of electricity. These frequent defrost cycle's mean that the conditions of ambient temperature and humidity do not allow to heat your pool water. The DEF code and the water temperature will be displayed alternately on the electronic control. Refer to the section titled “ Service Analyser Codes ” to validate what you should do.

Codes

If a code appears on the electronic control refer to Service Analyser codes (all models) on page 29.

Temperature Calibration

It is possible to have a temperature variation between the water in the swimming pool and the reading of the pool heat pump temperature probe (sensor). Example: if the water in the pool is 26° C (80° F) and the heat pump electronic control displays 24°C (76° F).

To calibrate this variation, perform the following procedure:

1. With the use of an accurate thermometer read the pool water temperature (e.g: 26°C).
2. Read the temperature displayed on the pool heat pump electronic control (eg: 24°C).
3. To determine the differential subtract the pool water temperature from the pool heat pump displayed temperature, $26 - 24 = 2^{\circ}\text{C}$. Therefore we must compensate for the 2°C variation.
4. Press **BOTH** the **UP** and **DOWN** arrow keys until the programmed temperature is displayed (the temperature you have previously set) then release both buttons.
5. Press the **ON/OFF** button and release.
6. Using the UP and DOWN arrows, enter the calibration value, (2°C). In this case, by pressing the UP arrow twice.
7. After 5 seconds when all the buttons have remained untouched , the display temperature will show the pool water temperature as per your thermometer. If this is the case the calibration process was successful.

Operation of Multi Function Electronic Control Panel

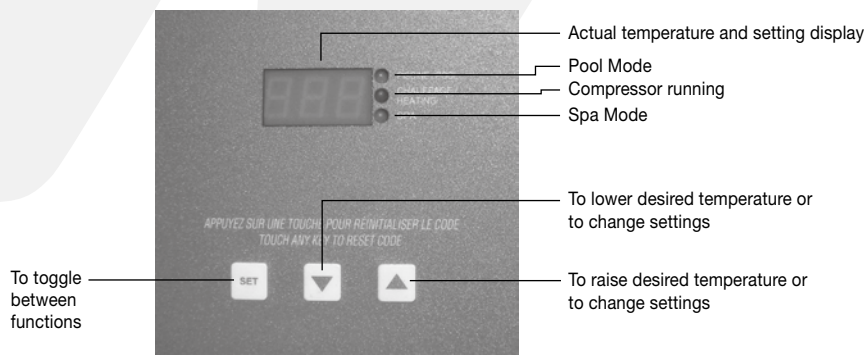

The temperature display of the electronic control panel is factory set to show pool water temperature in degrees FAHRENHEIT. See **“To select temperature in °C or °F”** section on the following page.

To Start The Pool Heat Pump

When the pool heat pump is turned **“ON”** or after a power shut down, the panel lights up and either indicates **“OFF”** or the temperature of the pool water circulating inside the pool heat pump.

When the unit is first turned on and water is flowing, the fan motor will start (blades will turn) followed by the compressor 3 to 5 minutes later. (the compressor and fan may start together when the unit has automatically cycled off for a period of time and then restarts)

To Stop The Pool Heat Pump

The pool heat pump can be stopped by switching off the electrical power supply or by setting the desired water temperature setting to below 60°F (15°C).

To Raise or Lower Desired Water Temperature (Pool or Spa Mode)

The Multi function electronic control has the capability of memorizing two different programmed temperature settings as follows:

For POOL the maximum is 95°F (35°C) and for SPA the maximum is 104°F (40°C)

To access the pool (**POL**) mode or spa (**SPA**) mode, press the **SET** key until you see **P-S** and then press the **UP** or **DOWN** key to switch to **POL** or **SPA**.

Push the SET key again to enter into the desired heating temperature mode.

Press the UP or DOWN arrow to increase or decrease the temperature setting by one degree at a time. Once the heating mode is programmed, it will be displayed for approximately 5 seconds; then the temperature display will return to the actual pool water temperature. The light on the right side of the display indicates the chosen heating mode .

To change display from Farenheit to Celcius

1. Press and release the SET key until **F-C** appears on the temperature display.
2. Whilst **F-C** is still on the display Press and release the **UP** or **DOWN** arrow key until C is displayed.
3. Release all keys and the control will now be set for Celcius. (do not press any other keys for 5 seconds)

To go back to Farenheit follow the same instructions above, however when you are at step 2, F will need to be shown on the display before releasing all keys

Defrost for Electroheat SubZero

During the defrost cycle, the fan motor stops working and the hot gas is injected into the evaporator to melt the frost. However, when the pool heat pump makes 5 consecutive cycles (heating and defrost) in less than 15 minutes, the unit goes into protection mode to avoid inefficient use of electricity. These frequent defrost cycle's mean that the conditions of ambient temperature and humidity do not allow to heat your pool water. The FS4 code will be displayed on the electronic control. Refer to the section titled " Service Analyser Codes " to validate what you should do.

Electrical connection of an automatic mode for the pool and spa (for Smart Energy model only)

The Multi Function electronic control has the ability to switch from POOL to SPA mode automatically. This function is used when warm water is directed towards the SPA. Activation is carried out by using an external water pressure switch connected to the SPA water line. This connection must be done by a qualified technician.

When the electronic control of the pool heat pump is located inside the electrical box the 2 wires coming from the pressure switch connected on the water piping going to the SPA (as shown on the right) must be connected at the boundaries of the electronic control of the pool heat pump.

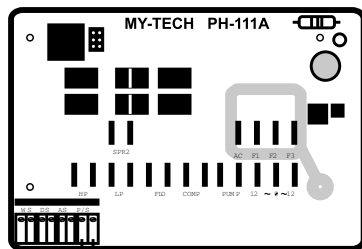

When the electronic control of the pool heat pump is mounted on the front panel of the unit:

The Orange and Orange-Black wires located inside the electric box junction of the pool heat pump must be connected to the water pressure switch connected on the water piping going to the SPA.

Electrical connection to an automation system to the pool (for Smart Energy model only) It is possible to carry out the connection of the Multi Function electronic control to an automation system for models P4 or P8. **This type of connection must be done by a qualified technician to ensure that your warranty will not be voided.**

For automation system operation, you will need to set the SPA temperature to maximum 40°C (104°F) and the POOL setting to “OFF”, so that when the automation system calls for heat; it will activate the SPA mode and starts the pool heat pump.

Note: When calling for a service technician, you will have to mention the installation of this type of automation system.

Codes

For codes refer to the section titled “Service Analyser codes”.

How to program the Multi Function electronic control timer to control your pool pump filtration

Note: This option is available only on the Smart Energy pool heat pump model.

The Multi Function electronic control includes an adjustable internal timer, which allows to control the filtration time of the pool pump. This timer allows **6 cycles of filtration** during a day.

Example:

Desired time of filtration: 3 hours / day = 180 minutes / day

Calculation: 180 minutes/day **DIVIDED** by 6 cycles of filtration/day = 30

Finally, your pool pump will work 6 times a day during 30 minutes; however, if the water temperature programmed has not reached, the pool pump will work until it reaches the programmed water temperature.

How to program the timer

1. Press the SET key until FIL is displayed;
2. If you want the pool pump to work continuously; press the up or down arrow until ON is displayed;
3. If you want the pool pump to work during a specific period, press the up or down arrow until the number of hours per day of the filtration that you desire is displayed (for example: you would like 3 hours/day, the number 3 must appear on the Multi Function electronic control).

Note: This type of programming FAVOURS the maintaining of the programmed water temperature rather than the time of filtration.

How to stop the timer

1. Press the **SET** key until the Multi Function electronic control displays **FIL**;

If you do not want to use the timer included in the Multi Function control, press the up or down arrow until **OFF** is displayed.

 **IMPORTANT**

Electrical connection required to use the integrated pool water pump timer of your pool heat pump.

Note: This option is available only for Smart Energy model.

If you wish to use the integrated timer of your pool heat pump; you must warn your electrician at the time of installation. **All electrical work should be performed by a fully qualified and licensed electrician in accordance with local electrical codes.** The pool pump **MUST** not consume more than 16 amps.

NOTE: The junction box of the timer does not provide power for the swimming pool pump, but instead switches the power (which is fed from another source) on and off to control the pump. An adequate circuit breaker dedicated to the swimming pool pump must be installed with copper wiring used in order for the beneficial functions of the timer. It may be necessary to install a ground fault circuit breaker.

Use the junction box at the base of pool heat pump
For model Smart Energy System Only

Wiring colour codes are:

- Green : Ground
- Black : Input L1
- White : Input L2
- Orange : Output T1
- Red : Output T2

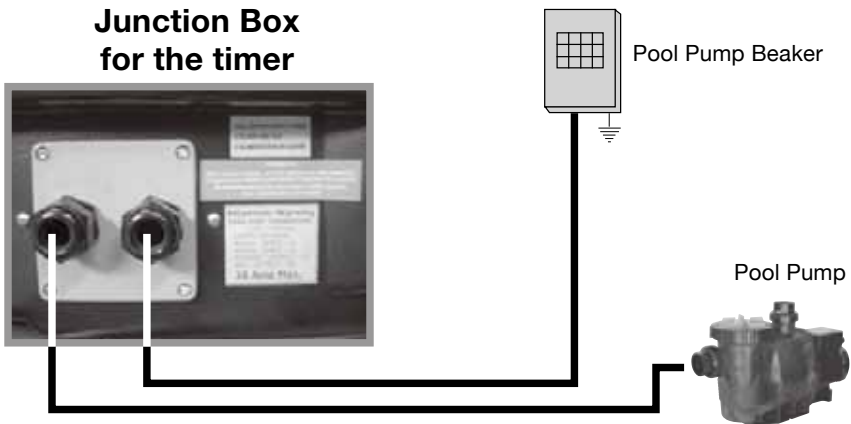

Protection devices

The integrity and performance of your pool heat pump and its components are protected by internal safety controls. In normal use, your Waterco unit should never reach the thermal protection level. However, if it should happen, you should identify the stated code on the temperature display and refer to Service Analyser codes.

Adjustment Of The Bypass Valves

The adjustment may vary according to pool pump size and ambient temperatures.

ATTENTION: IT IS VERY IMPORTANT THAT THE BYPASS VALVES ARE SET AS DESCRIBED BELOW FOR THE CORRECT FUNCTION OF YOUR POOL HEAT PUMP

VALVE POSITION

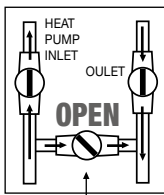

When the pool water temperature is between 65°F (18°C) and 70°F (21°C) please adjust the bypass valve as shown. Approx. 60% of the water is circulating in the unit.

VALVE POSITION

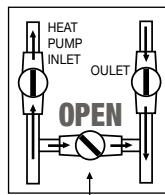

When the pool water temperature is between 70°F (21°C) and 78°F (26°C) please adjust the bypass valve as shown. Approx. 80% of the water is circulating in the unit.

VALVE POSITION

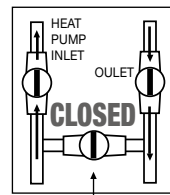

When the pool water temperature is above 79°F (26°C) please close the bypass valve as shown. 100% of the water is circulating in the unit.

MAINTENANCE OF YOUR POOL HEAT PUMP

Waterco pool heat pumps have been specifically engineered to give you years of satisfaction and enjoyment in the pool.

CABINET CLEANING

To clean the plastic surfaces use mild soapy water and a soft clean cloth. Never use solvents or abrasives.

CLEANING EVAPORATOR

It is vital that the evaporator is kept clean and un-obstructed in order for your pool heat pump to have better efficiency and avoid problems which may void your warranty. The dirt collected in the evaporator can be removed with a gentle water spray and the use of a soft brush. Be careful not to damage the aluminum fins.

Winterizing

VITAL

If the pool heat pump is stored in a place where the temperature drops below the freezing point of 0°C (32°F); it is **mandatory that the water accumulated in the pool heat pump be drained completely before freezing weather prevails. Improper winterizing may damage the pool heat pump and will void the warranty.**

- Turn the pool heat pump “**OFF**”.
- Turn the pool heat pump breaker “**OFF**”.
- The water piping **MUST** be disconnected to drain the pool heat pump’s heat exchanger in preparation for winter.
- Once the piping is disconnected, the pool heat pump’s heat exchanger **MUST** be emptied; the use of a water vacuum cleaner is strongly recommended or if you do not have this tool you can tilt the unit (75°) until all the water is out.
- It is recommended that pool heat pump’s heat exchanger is rinsed out with a gentle water spray at the inlet and outlet water connections of the pool heat pump and then drain the heat exchanger again.
- With the help of 2 pool return winter plugs, block the water Inlet and Outlet connections to prevent access by vermin.
- Clean the drainage holes located at the bottom of the base of the unit.
- Unit may be covered for the winter.
- It is also possible to fill the heat exchanger with pool anti-freeze, but ensure that the antifreeze contains an elevated pH to prevent corrosion. This is optional and requires appropriate hardware.

TROUBLESHOOTING

IMPORTANT

Please make sure you carefully read the troubleshooting section in order to avoid unnecessary service call fees.

Atmospheric conditions as well as the pool water temperature should not be below the minimum operating temperatures as stated below in order to obtain efficiency and avoid codes from appearing on the electronic control temperature display ; these codes are not generally a problem with the pool heat pump at these conditions and it is not covered by the warranty.

If temperatures are below the minimum temperatures listed the pool heat pump should not be operated and must be switched off.

For Electroheat SubZero and Reversible (XLR) units, they will automatically stop without human intervention.

| Model | Atmospheric conditions must be above | Pool water temperature must be above |
|---------------------|---|---|
| Electroheat SubZero | 32°F (0°C) | 50°F (10°C) |
| Reversible (XLR) | 43°F (6°C) | 65°F (18°C) |
| All others | 52°F (11°C) | 65°F (18°C) |

If you made the purchase of equipment not included with the Waterco pool heat pump, make sure that the equipment was properly installed. If the problem is the installation of the other equipment; Waterco warranty will not apply and you must pay the service call fees.

Nothing is working and the electronic control does not operate

1. Make sure the circuit-breaker has not tripped and/or that the fuses are not burn out;
****Take note that only an electrician can verify if the circuit breaker is defective; if this is the case, repairs will not be covered under the warranty.**
2. For three phase models, this situation could occur when phases are not in the appropriate order. The green led light on the front panel will not light up.
Please have a qualified electrician swap over two of the incoming phase wires.

Nothing is working but the electronic control temperature displays digits or a code

1. Identify the analyser code that the electronic control displays and refer to the Service Analyser codes section;
2. If the electronic control displays digits, make sure that the electronic control is programmed correctly, refer to the Operation of your pool heat pump and reprogram if necessary.

*****Note that this situation could occur when the electrical voltage is not respected as stated on the pool heat pump name plate. This situation is not covered by the manufacturer warranty.***

Fan doesn't work (the fan blades are not moving)

1. **IMPORTANT: For safety**, switch OFF the circuit-breaker.
2. Try to rotate the fan blades of the fan with a rod to see if the motor is jammed or seized
3. If the fan blades do not turn freely leave the unit switched OFF and call for service;
4. If the fan blades turn freely switch ON the circuit breaker and the pool heat pump again.

**** Note that your fan motor may have an electrical fault if the blades turn freely when the unit is switched OFF and does not start when the unit is switched ON.**

Fan blades turn, but compressor is not functioning

The pool heat pump has a built in delay timer which prevents the compressor from starting immediately. The delay can be 3 to 5 minutes in duration after the fan blades have turned. Furthermore if the unit is in defrost mode the compressor will not start for 3 to 20 minutes.

1. Check that air being discharged from the fan blades is colder than the ambient air. If the air being discharged by the fan blades is colder, it means that the compressor is functioning correctly.
2. Turn off the pool heat pump then immediately turn it back on;
3. As soon as the fan blades start turning, wait a minimum of 3-5 minutes. The compressor should start up after this time and you will be able to identify a different sound made by the compressor when it starts;

4. If the compressor is functioning, but shuts off immediately, consult the following section “ Compressor Starts and Stops “.
5. If the problem persists, call Waterco.

Compressor starts and stops

1. Check that the unit has been installed correctly (refer to installation procedures).
2. Check that the water inlet and outlet of the unit have not been connected incorrectly.

There is water around the pool heat pump

It is a normal occurrence for water condensation, to be seen running from the unit base. There will be on average 1 to 1.5 gallons (4 to 6 litres) of condensed water per hour being discharged from the unit base. In order to avoid water accumulation, you may use decorative rocks around the concrete slab or a basin under the unit. Be sure that clearances around the unit are respected.

To test the unit and confirm you have no pool water leaking from the unit perform the following test which is best performed early in the morning and continuing for the whole day:

1. Turn off the pool heat pump from the circuit breaker and the pool pump.
2. Open the bypass valve. (refer to drawing on page 5)
3. Close the **IN** and **OUT** water valves on the unit.
4. Restart the pool pump. The pool heat pump must remain **OFF**.
5. When all of the water around the base of the pool heat pump has dried, open the water **IN** and water **OUT** valves on the pool heat pump.
6. Close the bypass valve to allow full water flow through the pool heat pump.

If water is now seen running from the outside of the pool heat pump or inside the pool heat pump after a short period of time you should call for service. If no water is seen after a short period of time it would be assumed the water was condensation which is normal.

Pool heat pump has ice formed on the evaporator coil

Atmospheric conditions as well as the pool water temperature should not be below the minimum operating temperatures as stated below in order to obtain efficiency and avoid codes from appearing on the electronic control temperature display ; these codes are not generally a problem with the pool heat pump at these conditions and is not covered by the warranty.

If temperatures are below the minimum temperatures the pool heat pump should not be operated and must be switched off.

For Electroheat SubZero and Reversible (XLR) units, they will automatically stop without human intervention.

| Model | Atmospheric conditions must be above | Pool water temperature must be above |
|---------------------|--------------------------------------|--------------------------------------|
| Electroheat SubZero | 32°F (0°C) | 50°F (10°C) |
| Reversible (XLR) | 43°F (6°C) | 65°F (18°C) |
| All others | 52°F (11°C) | 65°F (18°C) |

1. **IMPORTANT: For safety**, switch OFF the circuit-breaker.
2. Allow the ice to melt and then inspect the evaporator to ensure it is free of debris and leaves.
3. If the evaporator is dusty or dirty, clean it with a light spray of water and allow it to dry (do not use high pressure it may damage the evaporator fins).
4. When the unit is dry, you may switch it back ON from the circuit breaker.
5. Ensure that the clearances around the unit are respected.
6. When the unit has been switched ON ensure the fan motor is working (fan blades will be turning) while the compressor is operating.
7. If the fan blade does not turn and the compressor is functioning; notify customer service.

***If the pool heat pump requires service, the owner of the pool heat pump will need to ensure the unit has been switched OFF to allow any ice to melt prior to any technician attending.*

Pool heat pump is functioning, but does not reach the desired temperature setting

Atmospheric conditions as well as the pool water temperature should not be below the minimum operating temperatures as stated below in order to obtain efficiency and avoid codes from appearing on the electronic control temperature display ; these codes are not generally a problem with the pool heat pump at these conditions and is not covered by the warranty.

If temperatures are below the minimum temperatures the pool heat pump should not be operated and must be switched off.

For Electroheat SubZero and Reversible (XLR) units, they will automatically stop without human intervention.

| Model | Atmospheric conditions must be above | Pool water temperature must be above |
|---------------------|--------------------------------------|--------------------------------------|
| Electroheat SubZero | 32°F (0°C) | 50°F (10°C) |
| Reversible (XLR) | 43°F (6°C) | 65°F (18°C) |
| All others | 52°F (11°C) | 65°F (18°C) |

IMPORTANT

Improper installation may cause this situation and will need to be corrected by the owner.

1. Make sure the by-pass valves are in the correct positions to ensure sufficient water flow, insufficient water flow will cause the compressor to shut off early.
2. If you have installed a timer or the pool heat pump is equipped with an integrated timer, be sure it is programmed to allow the pool pump to work for sufficient time in order to reach the programmed temperature.
3. Ensure the evaporator is cleaned regularly with a light spray of water and allowed to dry before re-starting the pool heat pump to avoid premature ice build up on the evaporator.
4. Waterco recommend the use of a solar cover to retain heat in pool water. Pools without covers lose 2 to 3 times more heat than pools with solar covers.
5. Make sure the electronic control of your pool heat pump has been programmed correctly; during this test the pool heat pump and water pump must be working continuously (eg; the desired water temperature must be set correctly).
6. If the unit continually fails to reach the desired water temperature, we suggest completing the following analysis chart and forwarding it to Waterco in order to avoid unnecessary service fees.

Analysis Chart

| Important: Please record all information for three consecutive days at 12h00 | Day 1 | Day 2 | Day 3 |
|--|--------------|--------------|--------------|
| Outside air temperature | | | |
| Weather conditions outside (eg: cloudy, sunny or rainy) | | | |
| Pool water temperature**Use a pool thermometer | | | |
| Pool water temperature **use the reading from the electronic control on the pool heat pump | | | |

| Important: Please record all information for three consecutive days at 20h00 | Day 1 | Day 2 | Day 3 |
|--|--------------|--------------|--------------|
| Outside air temperature | | | |
| Weather conditions outside (eg: cloudy, sunny or rainy) | | | |
| Pool water temperature**Use a pool thermometer | | | |
| Pool water temperature **use the reading from the electronic control on the pool heat pump | | | |

Circuit breaker trips

 **IMPORTANT**

If you have purchased a remote control (or other equipment), make sure this equipment was properly installed. If the problem originates from the installation of this equipment, Waterco's warranty will not apply and you will have to pay the cost of the service call.

1. The amperage of the circuit breaker AND the electrical wiring must be as the instructions on the pool heat pump name plate, otherwise notify your installer or electrician to correct this problem, as this is not covered under the warranty.
2. If the circuit breaker and electrical wiring are as stated, make sure the drains, located on each side of the base of the pool heat pump are not obstructed.

The pool heat pump is noisy

1. Check the pool heat pump is level and on a solid base to prevent any vibrations issues.
2. Ensure the noise is coming from the pool heat pump, not from other equipment which will not be covered by the warranty (for example: noise coming from the bypass valve, pool pump, etc);
3. An improper installation may cause this situation it will need to be corrected by the owner.

The temperature shown on pool heat pump is not the same that is shown by the pool thermometer

It is possible to have a temperature variation between the temperature shown on the electronic control temperature display of the pool heat pump and a pool thermometer which may be read from different locations. Please refer to the temperature calibration section in order to adequately recalibrate temperature if required.

Service Analyser Codes (All Models)

Most problems will be detected by the electronic control and a code will appear on the temperature display. Make sure you follow the Remedy / Action instructions where possible, before making a service call request and avoid paying unnecessary service call fees. If the code remains on the display after you have followed the Action / Remedy instructions, please contact Waterco.

| Code | Problem - Action / Remedy |
|-----------------|---|
| dPd, oC2, Sc2 | <p>Problem: The intake temperature probe has a loose connection or is faulty. The probe will need to be checked, and replaced if required.</p> <p>Action / Remedy: Contact customer service.</p> |
| FLo, FL3 nFL | <p>Problem: No water flow, not sufficient water flow through the pool heat pump or the water pressure switch needs to be adjusted or is defective.</p> <p>Action / Remedy: If the pool pump is connected to the pool heat pump make sure the electronic control that runs the pool pump and pool heat pump are programmed correctly</p> <p>If the code is still displayed:</p> <ul style="list-style-type: none"> - Make sure the pool pump is switched ON; - Press "SET" or "ON/OFF" depending on the model, to restart the pool heat pump; - On new installations, ensure the installation instructions were respected; - Check that the pool water level is correct, that the pool pump is filled with water to the rim and that water is flowing correctly through the pool pump to the pool heat pump; - Check swimming pool and pool pump skimmer baskets and the drain at the bottom of the pool for obstructions; - Check the filter cartridges for obstructions (wash or change the cartridges); - Carry out a backwash for sand filters and ensure they are working correctly; - Ensure that the bypass valves are in the correct positions so that the water flows adequately; - Ensure vacuum robot or other cleaners are disconnected so that the water flows freely. - Check that there are no leaks on the pool plumbing (there should be no air leaks in the pipework); |

| Code | Problem - Action / Remedy | | | | | | | | | | | | |
|---------------------|---|--------------------------------------|--------------------------------------|--------------------------------------|---------------------|------------|-------------|------------------|------------|-------------|------------|-------------|-------------|
| FS, DEF, FS4 | <p>Problem: Normal defrost cycle. The fan blades are turning, but the compressor has stopped. For Electroheat SubZero and Reversible model, the fan blades do not turn but the compressor runs.</p> <p>Action / Remedy: Normal during defrost duration. Atmospheric conditions as well as the pool water temperature should not be below the minimum operating temperatures as stated below in order to obtain efficiency and avoid codes from appearing on the electronic control temperature display ; these codes are not generally a problem with the pool heat pump at these conditions and is not covered under warranty.</p> <p>If temperatures are below the minimum temperatures the pool heat pump should not be operated and must be switched off.</p> <p>For Electroheat SubZero and Reversible (XLR) units, they will automatically stop without human intervention.</p> <table border="1" data-bbox="316 639 1022 810"> <thead> <tr> <th data-bbox="316 639 577 715">Model</th> <th data-bbox="581 639 798 715">Atmospheric conditions must be above</th> <th data-bbox="801 639 1022 715">Pool water temperature must be above</th> </tr> </thead> <tbody> <tr> <td data-bbox="316 719 577 746">Electroheat SubZero</td> <td data-bbox="581 719 798 746">32°F (0°C)</td> <td data-bbox="801 719 1022 746">50°F (10°C)</td> </tr> <tr> <td data-bbox="316 751 577 778">Reversible (XLR)</td> <td data-bbox="581 751 798 778">43°F (6°C)</td> <td data-bbox="801 751 1022 778">65°F (18°C)</td> </tr> <tr> <td data-bbox="316 783 577 810">All others</td> <td data-bbox="581 783 798 810">52°F (11°C)</td> <td data-bbox="801 783 1022 810">65°F (18°C)</td> </tr> </tbody> </table> <p>For Electroheat SubZero model: If the unit carries out 5 consecutive defrost cycles every 15 minutes or less, the pool heat pump is then put into protection mode (FS4). During this mode, the fan blade turns for 30 minutes in order to cool the evaporator. The pool heat pump restarts automatically when the external temperature is at: 34°F (1°C).</p> <p>For Reversible (XLR) Model: If the unit performs 4 consecutive cycles (heating and defrost) within 1-hour, the unit goes into protection mode and alternately displays the water temperature and the DEF code. The fan motor runs for 30 minutes to cool the evaporator and then stops. The compressor is always off. The unit restarts automatically when the outside temperature is 43°F (6°C) and more.</p> <p>If the code stays on permanently:</p> <ul style="list-style-type: none"> - Ensure the evaporator is clean. If not switch the unit OFF from the circuit breaker (fuse) and use a garden hose to lightly clean the evaporator, then allow it to dry before re-starting the pool heat pump to avoid premature ice build up on the evaporator. - Ensure installation instructions have been followed, Improper installation, e.g. no air circulation could lead to the pool heat pump continually going into defrost mode and the installation will need to be corrected by the owner. | Model | Atmospheric conditions must be above | Pool water temperature must be above | Electroheat SubZero | 32°F (0°C) | 50°F (10°C) | Reversible (XLR) | 43°F (6°C) | 65°F (18°C) | All others | 52°F (11°C) | 65°F (18°C) |
| Model | Atmospheric conditions must be above | Pool water temperature must be above | | | | | | | | | | | |
| Electroheat SubZero | 32°F (0°C) | 50°F (10°C) | | | | | | | | | | | |
| Reversible (XLR) | 43°F (6°C) | 65°F (18°C) | | | | | | | | | | | |
| All others | 52°F (11°C) | 65°F (18°C) | | | | | | | | | | | |

| Code | Problem - Action / Remedy | | | | | | | | | | | | |
|-----------------------|---|--------------------------------------|--------------------------------------|--------------------------------------|---------------------|------------|-------------|------------------|------------|-------------|------------|-------------|-------------|
| <p>LP, LP3</p> | <p>Problem: Low refrigerant level in the pool heat pump or the low-pressure safety control is defective.</p> <p>Atmospheric conditions as well as the pool water temperature should not be below the minimum operating temperatures as stated below in order to obtain efficiency and avoid codes from appearing on the electronic control temperature display ; these codes are not generally a problem with the pool heat pump at these conditions and is not covered by the warranty.</p> <p>If temperatures are below the minimum temperatures listed below the pool heat pump should not be operated and must be switched off.</p> <table border="1" data-bbox="280 545 985 718"> <thead> <tr> <th data-bbox="280 545 539 625">Model</th> <th data-bbox="539 545 761 625">Atmospheric conditions must be above</th> <th data-bbox="761 545 985 625">Pool water temperature must be above</th> </tr> </thead> <tbody> <tr> <td data-bbox="280 625 539 654">Electroheat SubZero</td> <td data-bbox="539 625 761 654">32°F (0°C)</td> <td data-bbox="761 625 985 654">50°F (10°C)</td> </tr> <tr> <td data-bbox="280 654 539 683">Reversible (XLR)</td> <td data-bbox="539 654 761 683">43°F (6°C)</td> <td data-bbox="761 654 985 683">65°F (18°C)</td> </tr> <tr> <td data-bbox="280 683 539 718">All others</td> <td data-bbox="539 683 761 718">52°F (11°C)</td> <td data-bbox="761 683 985 718">65°F (18°C)</td> </tr> </tbody> </table> <p>Action / Remedy:</p> <ul style="list-style-type: none"> - If the LP or LP3 code is shown permanently, press "SET" or "ON/OFF" depending of the model you have before to get to next step; - Ensure the evaporator is clean. If not switch the unit OFF from the circuit breaker (fuse) and use a garden hose to lightly clean the evaporator, then allow it to dry before re-starting the pool heat pump to avoid premature ice build up on the evaporator. - Ensure installation instructions have been followed. Improper installation, e.g. no air circulation could lead to the pool heat pump continually going into LP or LP3 mode and the installation will need to be corrected by the owner. | Model | Atmospheric conditions must be above | Pool water temperature must be above | Electroheat SubZero | 32°F (0°C) | 50°F (10°C) | Reversible (XLR) | 43°F (6°C) | 65°F (18°C) | All others | 52°F (11°C) | 65°F (18°C) |
| Model | Atmospheric conditions must be above | Pool water temperature must be above | | | | | | | | | | | |
| Electroheat SubZero | 32°F (0°C) | 50°F (10°C) | | | | | | | | | | | |
| Reversible (XLR) | 43°F (6°C) | 65°F (18°C) | | | | | | | | | | | |
| All others | 52°F (11°C) | 65°F (18°C) | | | | | | | | | | | |
| <p>HP, HP3</p> | <p>Problem: Low water circulation in the unit or the high-pressure control is defective. If the HP code is triggered and displayed 3 times; this will cause the pool heat pump to shut down automatically. The HP3 code will then appear permanently (except for reversible electronic control with diagnostics).</p> <p>Note: The pool pump will stop functioning only if the internal time delay of the pool heat pump is being used.</p> <p>IMPORTANT: When the code HP3 is permanently displayed, before performing the steps below, please press the "SET" button for the electronic control Multi Function and "ON / OFF" for the electronic control with diagnostics and the reversible electronic control with diagnostics (XLR) and electronic control with diagnostics.</p> | | | | | | | | | | | | |

| Code | Problem - Action / Remedy |
|---------------------------|--|
| HP, HP3 | <p>Action / Remedy: Make sure the water reaches the pool heat pump and the pool pump is completely filled to the rim. Otherwise:</p> <ul style="list-style-type: none"> - Fill the pool pump with water, and check to see if the pipes between the pool pump and the pool are watertight (there should be no air intake); - Check the swimming pool and pool skimmer baskets and the drain at the bottom of the pool for obstructions; - Check the filter cartridges for obstructions (wash or change the cartridges, as the case may be); - Insure that the bypass valves are in the correct positions so that the water flows adequately; - Backwash sand filter (insure that there is a sufficient amount of sand and verify that it does not have to be changed. Consult a swimming pool specialist if necessary); - Make sure the vacuum robot is disconnected so that the water flows freely. |
| OFF | <p>Problem: The desired water temperature setting programmed is below 60°F (15°C) for the Multi function electronic control OR the electronic control with diagnostics is OFF or could be defective.</p> <p>Action / Remedy: Reprogram the desired water temperature setting to a higher setting for the electronic control with Multi Function. For the electronic control with diagnostics and the reversible electronic control with diagnostics (XLR), press on key "ON/OFF".</p> |
| PSD, oC1 & Sc1 | <p>Problem: The water temperature probe has a loose connection or is faulty. The probe will need to be checked and replaced if required.</p> <p>Action / Remedy: Contact customer service.</p> |
| ot | <p>Problem: Water temperature is higher than 45°C (113°F) within the unit (this code is only displayed on the electronic control with diagnostics).</p> <p>Action / Remedy:</p> <ul style="list-style-type: none"> - Make sure the bypass valves are in the correct positions; - Proceed to the calibration of the electronic control with diagnostics and reversible electronic control with diagnostics (XLR). |

WARRANTY

IMPORTANT

Before you contact Waterco for assistance or service, please check the “**Troubleshooting**” and the information stated in this section. Warranty will only cover manufacturing defects. All service call requests which are not of this nature must be paid by the purchaser to the service company authorized by Waterco.

All services will be handled by the authorized service company. Warranty may be voided if service is not carried out by a service company center authorized by Waterco.

DO NOT return the pool heat pump to your dealer as they do not provide the service work.

Before you contact Waterco for assistance or service, in order to qualify for a warranty claim, the original purchaser must have the model name and serial number along with a proof of the original purchase date. Proof of purchase must be forwarded to Waterco and they will inform you of the applicable warranty.

Once connected with a Waterco customer service agent, proceed to describe in detail the the problem associated with your pool heat pump. If a permanent code appears on the electronic control panel, please advise the Waterco service agent.

Warranty

Waterco guarantees to the original purchaser of the pool heat pump that the product is free from any manufacturing defect (raw materials and labour).

IMPORTANT : The warranty is not transferable and no action can be exercised by a consumer subsequent purchaser of the pool heat pump.

When buying the pool heat pump, Waterco guaranteed parts and labour for a specific determined period to correct defects in materials or workmanship. Contact Waterco to find out the warranty that is applicable for your model.

There is no other warranties, express or implied, including, but not limited to, implied warranties of merchantability or fitness for a particular purpose. During warranty period, Waterco will, at its option, repair or replace, without charge, any product or part, which is found to be defective under normal use and service.

Waterco does not guarantee and will not pay for:

- A. Service calls to:
 1. Inspect and/or correct the installation of your pool heat pump.
 2. Instruct you on how to use your pool heat pump.
 3. Replace house fuses or correct power supply problem.
 4. Adjust or reestablish water flow to the pool heat pump.
- B. When a service call with no manufacturing problem has been detected, on site, by the service company mandated by Waterco.
- C. Damage to your pool heat pump caused by accident, misuse, fire, flood, acts of God, improper installation, harsh environment, chemical feeding before the pool heat pump, improper maintenance of water chemistry or any problem related with instructions not followed and described in this manual by the purchaser and/or the end-user.
- D. Damage to internal piping or components due to improper winterizing before freezing conditions.
- E. Repairs to parts or system resulting from unauthorized modification made to the pool heat pump.
- F. Repairs not previously authorized by Waterco.
- G. Parts and pool heat pump transportation.
- H. Fees charged for excessive time to repair your pool heat pump due to incorrect or un-accessible location This may void warranty cover and the owner will be required to pay a service call fee even if the unit is not repaired.

Waterco's obligation to repair or replace at Waterco's option, shall be the original purchaser's sole and exclusive remedy under this warranty. Waterco shall not be liable for incidental, consequential or special damages arising out of or in connection with product use or performance.

Waterco is not responsible for direct or indirect damages resulting from defective components. This warranty gives you specific legal rights and you may also have other rights, which vary from state or province to another.

AUSTRALIA

NSW - Sydney (HEAD OFFICE)

Tel : +61 2 9898 8686

VIC/ TAS - Melbourne

Tel : +61 3 9764 1211

WA - Perth

Tel : +61 8 9273 1900

QLD - Brisbane

Tel : +61 7 3299 9900

SA/ NT - Adelaide

Tel : +61 8 8244 6000

CANADA / NORTH-EAST USA

Waterco Canada Inc

Tel : +1 450 796 6002

+1 888 796 6002

USA

Waterco USA Inc

Augusta, USA

Tel : +17067937291

+18002477291

NEW ZEALAND

Waterco (NZ) Limited

Auckland, New Zealand

Tel : +64 9 525 7570

EUROPE

Waterco (Europe) Limited

Sittingbourne, Kent. UK

Tel : +44(0) 1795 521 733

CHINA

Waterco (C) Limited

Guangzhou, China

Tel : +8620 3222 2180

MALAYSIA

Waterco (Far East) Sdn. Bhd.

Selangor, Malaysia

Tel : +60 3 6145 6000

website: www.waterco.com

This web site address will enable you to select the appropriate website for the country you are in.

WATERCO

Waterco Limited ABN 62 002 070 733

Member
WATER
QUALITY
ASSOCIATION

