

WATERCO POOL HEAT PUMP WATERCO THERMOPOMPE CHAUFFE-PISCINE

Electr  Heat
ECO-V 25kW

Installation and Operation Manual Manuel d'installation et d'utilisation



WARNING

This equipment must be installed and serviced by a qualified technician. Improper installation can create electrical hazards which could result in property damage, serious injury or death. Improper installation will void the warranty.



Cet équipement doit être installé et réparé par un technicien qualifié. Une mauvaise installation peut entraîner des risques électriques qui pourraient provoquer des dommages, des blessures graves ou la mort. Une installation inadéquate annulera la garantie.

Notice to Installer / Avis à l'installateur

This manual contains important information about the installation, operation and safe use of this product. Once the product has been installed this manual must be given to the owner/operator of this equipment.

Ce manuel contient des informations importantes sur l'installation, l'exploitation et l'utilisation sécuritaire de ce produit. Une fois que le produit a été installé, ce manuel doit être remis à l'acheteur et/ou utilisateur de cet équipement.

Table of Contents

IMPORTANT SAFETY INSTRUCTIONS	02	MAINTENANCE OF YOUR POOL HEAT PUMP	29
A NOTE TO YOU	03	Cabinet Cleaning	29
INSTALLATION INSTRUCTIONS	05	Cleaning Evaporator	29
Location	05	Cleaning drainage holes	29
Installation Accessories	05	Units Located In Coastal Locations	29
Installation Clearances	08	Winterising Procedure	30
Water Piping	09	GENERAL SAFETY INSTRUCTIONS	31
External Flow Switch	09	TROUBLESHOOTING	32
Water Flow Rate	09	Nothing Is Working and The Electronic Control Does Not Operate	32
Water By-pass Kit	09	Nothing Is Working But The Electronic Control Temperature Displays Digits or a Code	32
Plumbing Diagram	10	Fan Doesn't Work (The Fan Blades Are Not Moving)	32
Electrical	11	Fan Blades Turn, But Compressor Is Not Functioning	33
Electrical Connection	11	Compressor Starts and Stops	33
Breaker Size	11	There Is Water Around The Pool Heat Pump	33
Electrical Wire Size	11	Pool Heat Pump Has Ice Formed On The Evaporator Coil	34
Bonding	12	Pool Heat Pump Is Functioning, But Does Not Reach The Desired Temperature Setting	34
Remote Control Connections	13	Circuit Breaker Trips	35
Usage Of Chemical Products	14	The Pool Heat Pump Is Noisy	35
Refrigerant Charge Indicator Gauge	14	The Temperature Shown On Pool Heat Pump Is Not The Same That Is Shown By The Pool Thermometer	35
Performance Specifications	15	Dimensional drawing of heat pump	36
OPERATION OF YOUR POOL HEAT PUMP	16	Electric Circuit Drawing	37
Initial Heating	16	Service Parameters Tables	38
Adjustment Of The Bypass Valves	16	Parameter Table	39
Pool Heat Pump Running Time	17	Parameter Setting	40
Pool Solar Blanket	17	Function Setting	41
Defrost Cycle	17	WARRANTY	43
INVERTER POOL HEAT PUMP CONTROLLER	18		
Switch And Lock Function	18		
Mode Switching	19		
Main Device Operation Display	21		
Timing On/Off Setting	22		
View Function	26		
Parameter Setting Function	27		

IMPORTANT SAFETY INSTRUCTIONS

When using this electrical equipment, basic safety precautions should always be followed, including the following:

READ AND FOLLOW ALL INSTRUCTIONS

! WARNING: Disconnect all AC power during installation and servicing.

! WARNING: In order to avoid the possibility of hyperthermia (heat stress) occurring it is recommended the average temperature of the spa - pool water does not exceed 40°C / 104°F.

! WARNING: The pool heat pump is not intended for use by persons (including children) with reduced physical sensory or mental capabilities, or lack of experience and knowledge, unless they have been provided supervision or instruction concerning use of the appliance by a person responsible for their safety. Children should be supervised to ensure they do not play with the appliance.

- In certain situations unexpected start up may occur when the appliance is in automatic mode.
- The installer should assess the risk associated with unexpected start-up of this device which, in any circumstance should have no hazardous effect.
- The pool heat pump is not meant to provide safety protection for other devices.
- The pool heat pump should be deactivated if the pool or spa has been drained.
- Waterco pool heat pumps must be installed by a suitably qualified person in accordance with current Regulatory Standards, the applicable Wiring Rules (AS3000) and local statutory authority regulations.
- Parts containing live parts, except parts supplied with safety extra-low voltage not exceeding 12V, must be inaccessible to a person in the spa - pool.
- Parts incorporating electrical components, except remote control devices, must be located or fixed so that they cannot fall into the spa - pool.
- The appliance should be supplied through a residual current device (RCD) having a rated residual operating current not exceeding 30mA.
- An Earth terminal is located inside the wiring enclosure. To reduce the risk of electric shock, this terminal must be connected to the grounding means provided in the electric supply service panel with a continuous copper wire as sized to comply with current Standards and local statutory authorities in relation to the circuit conductors supplying the equipment.
- A cable connector is provided on this unit to connect a suitably sized copper conductor between this unit and any metal equipment, metal enclosures of electrical equipment, metal water pipe, or conduit within 1.5m of the unit via equipotential bonding.

SAVE THESE INSTRUCTIONS.

A NOTE TO YOU

Congratulations!

Thank you for choosing a Waterco Electroheat ECO-V inverter heat pump to heat your pool.

Using the latest technology in heat capture, the Waterco pool heat pump converts the energy released by the sun and transfers it efficiently to your swimming pool.

During certain periods it may be necessary to operate your pool heat pump continuously during the day in cooler periods however, this should not be of concern as your Waterco pool heat pump can heat up your pool approximately 80% more economically than the fossil fuel heating or heaters with electric elements. Waterco pool heat pumps are designed specifically to heat or cool your swimming pool economically.

To appreciate the benefits this product will bring you, make sure to operate the unit when the atmospheric conditions specified in this document are present in addition of using a solar blanket to minimize heat loss which will influence operating costs and size of the unit required. Pools not covered with a solar blanket lose 2 to 3 times more heat, regardless of types of heating!

This manual applied to the following models:

Electroheat ECO-V 25kW - heat / cool with automatic evaporator deicing

Transportation and Storage

1. The heat pump MUST be transported and stored VERTICALLY!
2. Should the heat pump be laid down, please wait at least 12 hours before switching it on.

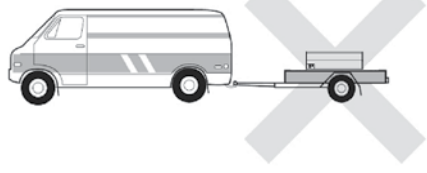
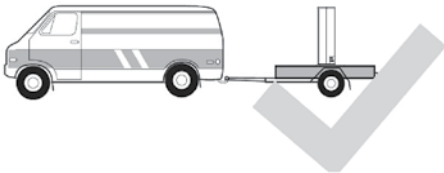

Record your model's information.

Keep this manual and your original proof of purchase receipt for warranty and future reference.

On the base of your pool heat pump is a name plate which contains information such as model number, serial number and electrical information.

Please write these down below and have them handy incase of a service call request.

Model Number _____

Serial Number _____

Purchase Date _____

Dealer Name _____

Dealer Address _____

Dealer Phone _____

To find detailed product information, the location of the nearest dealer or to register your pool heat pump please visit our website www.waterco.com and select your location.

INSTALLATION INSTRUCTIONS

Location

To gain maximum efficiency for your pool heat pump please follow all instructions when “positioning the unit”. It is also important to allow clearances for future service and maintenance procedures.

The unit is designed for outdoor installation and should not be installed in a totally enclosed area such as a shed, garage, etc., unless ducted and fan assisted ventilation of the cold exhaust air is provided to ensure adequate air exchange for correct operation. Re-circulation of cold discharged air back into the evaporator coil should be avoided and will greatly reduce unit’s heating capacity and efficiency.

The unit should be located as close as practically possible to the existing pool pump and filter to minimize water piping. The use of 90 degree bends and short radius elbows in the water piping should be kept to a minimum.

Mount the unit on a sturdy base, preferably a concrete slab. The base should be completely isolated from the building foundation or wall to prevent the possibility of sound or vibration transmission into the building. The size of the base should not be less than the base mounting feet dimensions of the pool heat pump.

LOCATING THE INSTALLATION ACCESSORIES

Included with the heat pump are some installation accessories which are located **INSIDE** the heat pump cabinet as shown below.

- Step 1:** Locate the front panel of the unit on the right side of the fan outlets.
- Step 2:** Remove the 6 locating screws from the cabinet and slide the compartment cover downward two centimeters.
- Step 3:** Carefully pull the compartment cover outward.
- Step 4:** Remove the accessories bag and drainage piping.



front cover

The accessories bag contains:-

- 2 x 40mm slip water pipe connections
- 4 x anti-vibration mounts



Drainage Spigots & Hose

Locate the two drainage spigots underneath the rear of the unit and turn outward. Fit the supplied drainage tube to the spigots and direct downward towards a suitable drainage area.

The unit should be maneuvered into its final position and anti vibration mounts fitted under each foot. Each foot may then be bolted down to the concrete slab (supplied by other).

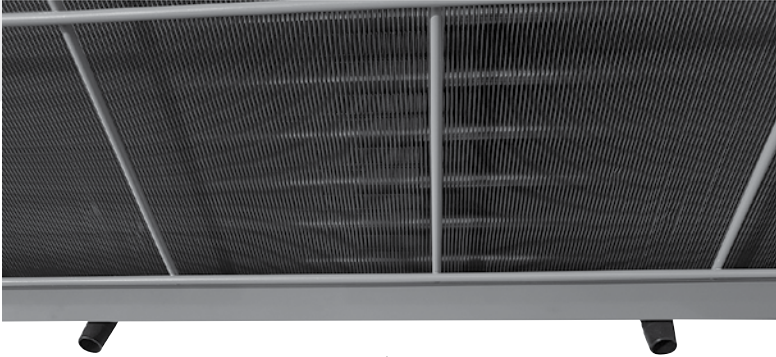

spigots

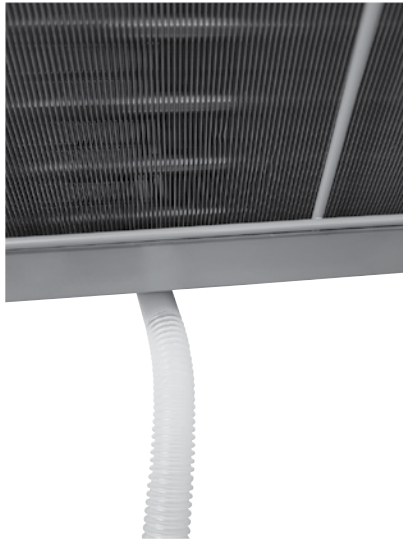

drainage

Installation Clearances

Air is pulled through the evaporator coil at the rear of the unit and discharged from the two front fan grills. Clearances must be allowed in front and around the unit for unrestricted air discharge and service access. See Figure 1. Failure to comply to the set clearances may cause diminished unit performance and reduce unit longevity.

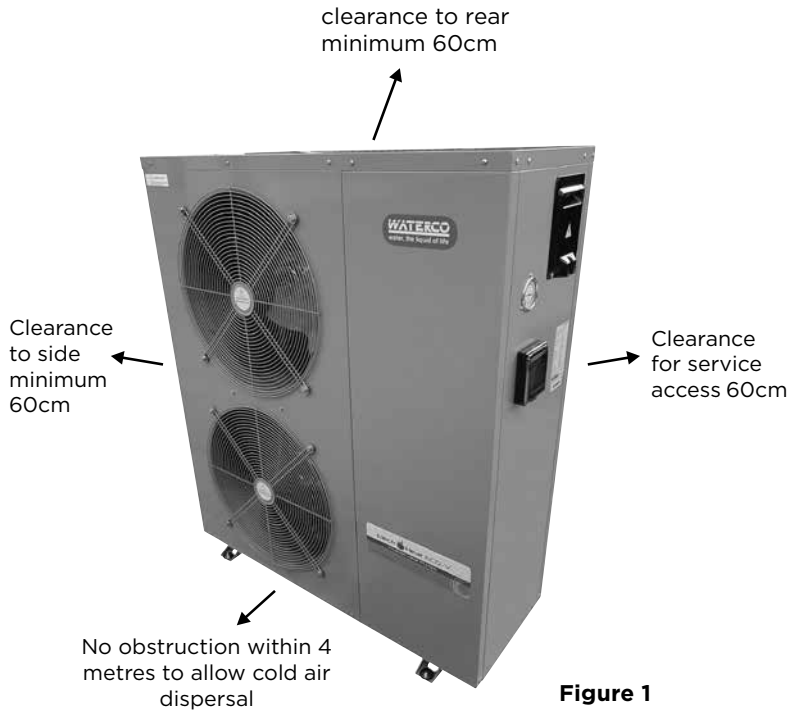

Figure 1

Water Piping

The supplied plumbing layout must be followed without exception:

1. pool pump
2. filter
3. pool heat pump
4. chlorinator (when installed).

Rigid PVC piping is recommended with all joints primed and glued with a suitable PVC adhesive cement. If rigid PVC pipe is not available, a suitable flexible hose of adequate diameter may be utilised with stainless steel clamps. When the piping installation is complete, operate the pool pump and check the system for leaks. Then check the filter pressure gauge to see that excessive pump head pressure is not indicated.

Water Flow Rate

The recommended water flow rate range varies depending on the size of the heat pump to ensure maximum heat transfer efficiency. The optimal flow rate is the mid point of this range. Use the bypass valve to adjust the flow rate to within the recommended range. See Performance Specifications table page 13.

Water By-pass Kit

A bypass kit consisting of 3 X two way valves must be installed for adjustment of water flow and ease of service. Waterco offer prefabricated water bypass kits to fit their heat pump domestic range. Ask your local Waterco sales office for details.



Plumbing Diagram

⚠ VITAL

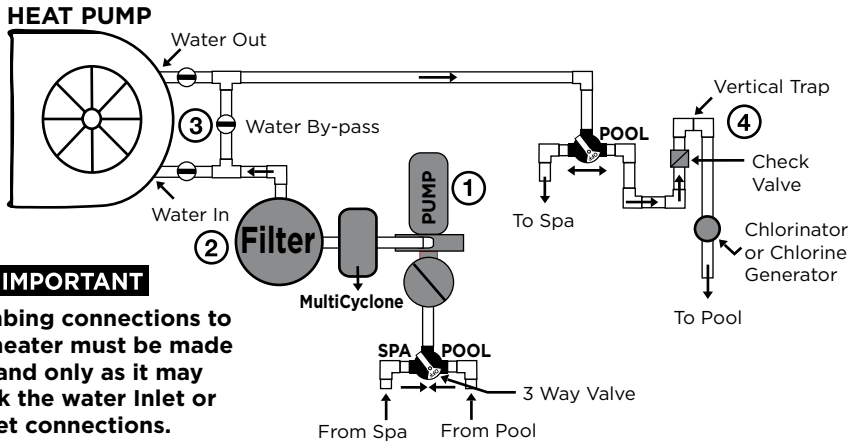

👉 IMPORTANT

Plumbing connections to the heater must be made by hand only as it may break the water Inlet or Outlet connections.

1. A check valve or a loop **MUST** be installed between the pool heat pump and any automatic chlorinator to prevent highly chlorine concentrated water from flowing back to the pool heat pump when the pool pump is not running.
2. These units are fitted with a flow switch which are not effected by water pressure. Therefore, the fitment of a flow check valve due to the installed height either above or below water level is not required.
3. For units installed above the pool water level the return water to the pool valve on the bypass valve set should be closed approximately 15-20% to ensure the heat exchanger is completely full of water to allow heat transfer to occur.

IMPORTANT

Electrical

All electrical work should be performed by a fully qualified and licensed electrician in accordance with local electrical codes.

An adequate circuit breaker and copper wiring must be used. Electrical requirements are available on the name plate of the pool heat pump. It may be necessary to install an earth leakage circuit breaker.

Waterco recommend connecting the unit to an isolating switch to allow ease of service and maintenance.

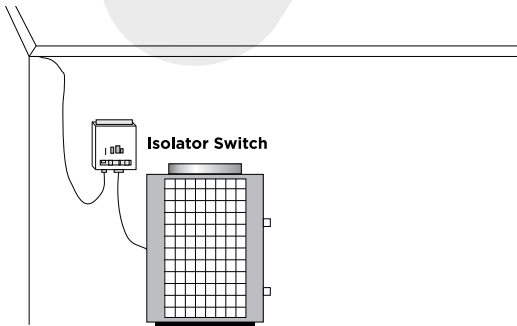

WARNING THE POOL HEAT PUMP MUST BE DISCONNECTED BEFORE OPENING THE ACCESS PANEL.

Electrical Connection

Standard 60 Hz power supply : 220/240 v - 50Hz-1 phase

Standard 50 Hz power supply : 220/240 v - 50Hz-1 phase

Breaker Size

Please consult name plate on the base or the side of your pool heat pump for starting amperage and required breaker size.

Electrical Wire Size

Please consult a qualified and licensed electrician.

WARNING The power cable ground must be connected to the electrical panel and to the ground lug of the pool heat pump. An improper installation may be a potential cause of fire, electrical shock or injury.

Bonding

⚠ VITAL

In some locations bonding of the pool equipment and pool substructure may be required by law. Because all metals have different electrical potentials, **ALL metal and electrical components of the pool system MUST be bonded together.** This includes the metal framework of the pool, the light, the pump, the filter (if metal), the pool heat pump, any automatic chlorine generator, and any other metal or electrical equipment bonded to your pool.

On some older pools, this substructure bond wire may not exist. In these cases, a 3-4 foot solid copper rod must be driven into the ground near equipment; all electric and metal components must be bonded to each other, and to the copper rod. Warranty will be voided if system is not properly bonded.

CAUTION: Some of these systems may leak stray voltage and currents into the water causing severe electrolysis. This dramatically shortens the life of the pool heat pump and will void the warranty.

When an automatic chlorinator is installed on a pool circulation system, it is important the equipment is correctly installed and bonded (earthed). Some systems may leak stray voltage and currents into the water causing severe electrolysis which could shorten the life of the pool heat pump.

NOTE: Bonding to pool pump is not required to above ground pool pumps but all other equipment must be bonded.

Bonding Diagram

⚠ VITAL

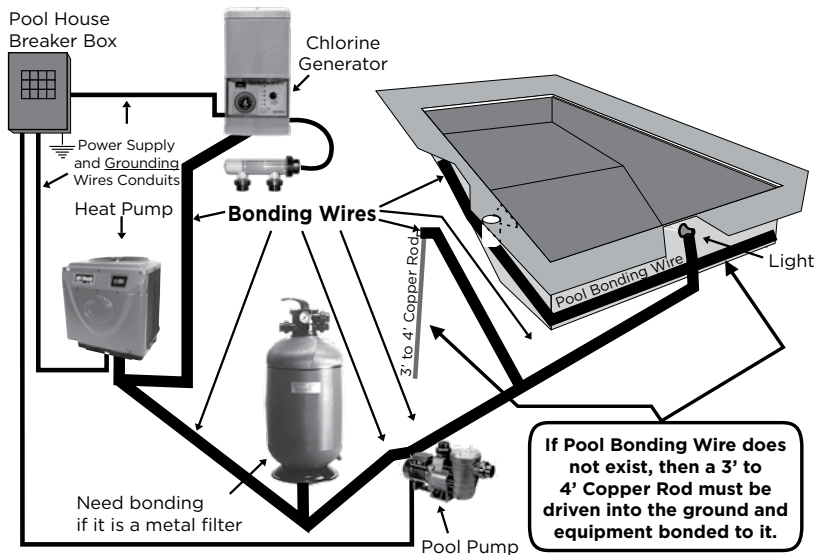

Remote Control Connections

1. Switch off power to heat pump at main circuit breaker panel/isolator.
2. Unbolt and remove the front access panel.
3. Open control box cover.
4. To connect a 2-Wire Control such as Waterco Aquamaster™:
 - ii) Locate the main printed circuit board and cable connected to terminal WS (water switch) or find the cable connected to the water switch mounted on the heat exchanger inside canister the unit.
 - ii) Cut **one** of the two water switch cables WS and connect the two ends of the cut cable separately to the two ends of the incoming external controller cable and make electrically safe. Use 1mm² minimum cable size with a minimum 1.2mm thick insulation rated for a temperature of at least 105°C / 221°F.
5. Close control box cover.
6. Re-install the access panel. To control heaters that are operated in parallel, connect wiring at same locations on heater control. It is imperative that each control circuit is isolated from the other control circuits; to avoid current flow from one heater to another through the control circuits.



water switch

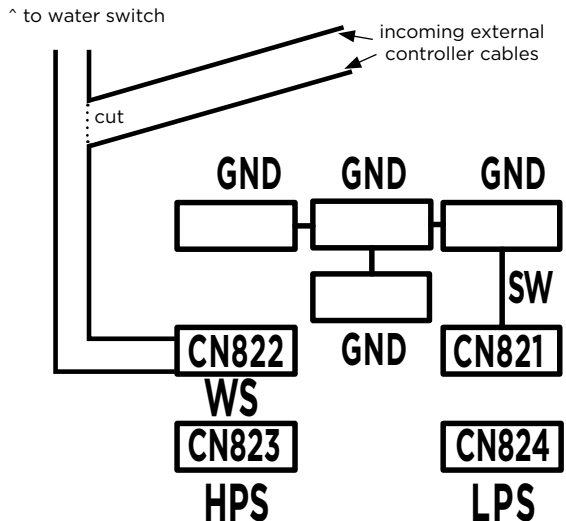

Usage Of Chemical Products

When adding chemicals to your pool or spa, follow the manufacturers guidelines for application and dosing levels.

Allowing high concentrations of chemicals through the heater should be avoided. Resultant damage may be inflicted on the heater.

Water quality standards that must be strictly adhered to*:

DESCRIPTION	NORMAL RANGE*	VERIFY
PH Level	7.2 - 7.6	1 per week
Chlorine Concentration	2 - 5 PPM	1 per 2-3 days
Total Alkalinity	80 - 150 PPM	1 per 2-3 weeks
Total Dissolved Solids	Below 1500 PPM Reg Pool Below 7500PPM Salt Pool	1 per month 1 per month
Calcium Hardness	200 - 300 PPM	1 per month
Salt Level	4000 - 6000 PPM	

* Warranty can be voided if not maintained within these ranges.

Refrigerant Charge Indicator Gauge

The refrigerant charge gauge is provided to monitor the refrigerant charge within the heat pump. When the heat pump is operating, the gauge needle would point to the pressure value of refrigerant with the maximum value of protection of 42kg/Cm². When the heat pump is off, the gauge needle would point to the same value as actual ambient temperature (e.g. 28°C) and related air pressure (e.g. 18kg/Cm²).

If the needle is pointing in the range of 0 - 3 then it may indicate low refrigerant charge and should be checked by a qualified technician.

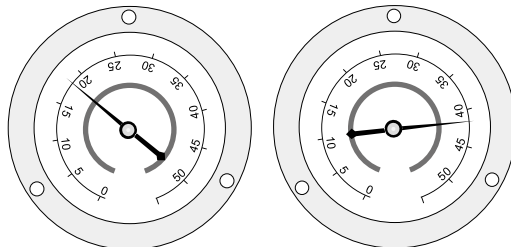

Performance Specifications

Model		Electroheat ECO V 25KW	
Air 27°C/ Water 26°C	Heating Capacity	KW	27.0 ~ 14.3
	Power Input	KW	5.1 ~ 1.75
	COP		5.3 ~ 8.2
	Normal Current	A	24.2 ~ 3.95
Air 15°C/ Water 26°C	Heating Capacity	KW	24.1 ~ 6.1
	Power Input	KW	5.25 ~ 0.85
	COP		4.6 ~ 7.2
	Normal Current	A	24.2 ~ 3.95
Power Supply		V/Ph/Hz	230 - 240V/50Hz
Supply Voltage Phase			Single Phase
Breaker or Fuse Size		Amps	32
Electrical Connection			Terminals
Setting Temp. Range		°C	15°C ~ 40°C
Running Temp. Range		°C	-10°C ~ 43°C
Water Heat Exchanger			Titanium Coil / PVC Tank
Heat Exchanger Max. Pressure			3.5 bar / 350kPa
Compressor			Inverter
Compressor Quantity			1
Fan quantity			2
Exhaust Direction			Horizontal
Water Inlet/Outlet Dimension			1.5"
Hydraulic Connection		MM	40 SLIP
Nominal Water Flow		LPM	165 - 195
Sound Pressure Level at 1M		dB(A)	50 ~ 58
Sound Pressure Level at 10M		dB(A)	32 ~ 40
Unit Dimentions(L*W*H)		MM	1092 x 402 x 1276
Cabinet Material			Power Coat Steel
Net Weight		Kg	126
Refrigerant			R410A (3.45kg)
Display			LCD
Mode			Heating/Cooling

OPERATION OF YOUR POOL HEAT PUMP

Initial Heating

To achieve initial heating, your pool heat pump and the pool pump may require extended operation until desired temperature is achieved. The initial heating time may vary depending upon the five factors listed below. After initial heating, operating time may be reduced to match daily heat loss.

1. Size of the pool.
2. How many degrees the water is to be heated.
3. Ambient air temperature - the warmer the air, the less time required to heat.
4. Use of a solar blanket.
5. The size of the pool heat pump.

If a combination of the atmospheric and water temperatures are below the minimum listed concurrently the pool heat pump should not be operated and be switched off.

Generally, atmospheric conditions (air temperature) will be warmer during day time hours. To accelerate the initial heating period owners may opt to increase the ambient air temperature artificially around the evaporator area of the pool heat pump until the pool water temperature has reached the minimum required as stated below.

Model	Atmospheric conditions must be above	Pool water temperature must be above
Electroheat ECO-V	0°C / 32°F	10°C / 50°F

Adjustment Of The Bypass Valves

Waterco ECO-V pool heat pumps do not require the water by pass valves adjusted to cope with cooler water temperatures. In the event of low water temperatures, the ECO - V inverter pool heat pumps increase the operating frequency of the compressor which in turn increases the output capacity of the unit.

It is essential water flow through the unit is within the range specified in the Performance Specifications table on page 15. The bypass valve may be used to tune the water flow within range.

The adjustment may vary according to pool pump size.

Pool Heat Pump Running Time

Most units should be sized to operate during the pool filtering cycle time of 8-12 daytime hours daily during warmer months and up to 8 hours daily during the daytime in winter months. On warmer days the pool heat pump will run less because the heat loss will be less.

IMPORTANT

Condensation

Your pool heat pump will accumulate condensed water (approx. 4 to 6 litres or 1 to 1.5 gallons per hour), therefore causing water to drain out of the unit base. In order to avoid water accumulation, you may use decorative rocks around the concrete slab or a basin under the unit. (Please note this is a normal characteristic of a pool heat pump and not a service or warranty issue.)

The supplied hose may be connected to the spigots fitted prior to final unit installation to direct the condensate away from the heat pump.

Pool Solar Blanket

A pool solar blanket should be used whenever possible. Blankets minimize heat loss through evaporation and conserve heat in your pool. Un-blanketed pool can lose 2-3 times more heat than a blanketed pool.

Defrost Cycle

When any of the following conditions occur the electronic control of your unit will activate a defrost mode until most of the frost from the evaporator has melted. Condensation of water on the evaporator coil tends to frost up quicker when the following occur.

1. When atmospheric conditions are as stated above;
2. When the evaporator is dirty;
3. When installation clearances are not respected.

Defrost is activated for between 3 to 20 minutes.

INVERTER POOL HEAT PUMP CONTROLLER

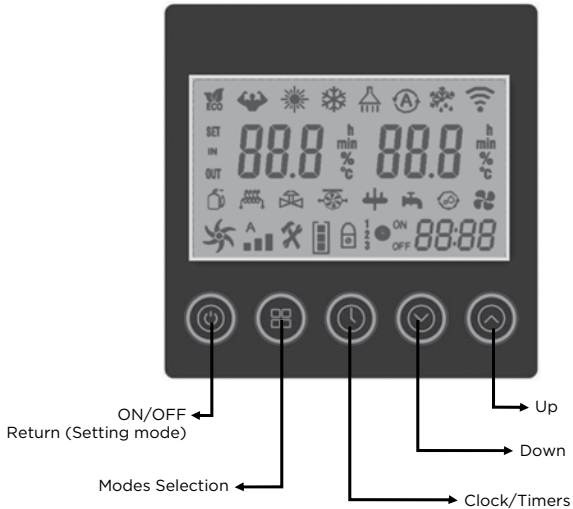

1. Switch and lock function



1.1 Icon definition

 Lock icon-when the icon lights up, the display screen is locked;

1.2 ON/OFF operation steps

Step 1: Press this switch button  to switch on/off;

Step 2: In the main screen, press this key to shut down the unit; in other setting screen, press this key to return to the main interface;

1.3 Unlock operation steps

1.3.1 Five-key remote control (lock): Long press this switch button for  3s (or no operation of the remote control for 60 seconds) to lock the remote control (used to prevent children from touching and playing randomly) , In the locked state, pressing other keys is invalid.

Lock light  Light this icon to indicate that it is locked.

1.3.2 Five-key remote control (unlocked): In the locked state, long press this key  for 3 seconds to change from the locked state to the unlocked state, and press other keys to operate at this time.

2. Mode switching



Modes Selection

2.1 Icon definition



Energy saving mode

The heat pump compressor operates in the most energy-efficient and way.



Heating mode

In this mode, the heat pump continues to heat the water temperature to the set temperature point.



Powerful work mode

In this mode, the heat pump operates at the highest frequency, heating to the set temperature in the shortest time;



 Energy-saving heating mode



 Powerful heating mode



Cooling mode

In this mode, the heat pump uses cooling to reduce the water temperature to the target temperature.

Defrost mode







The system's automatic or manual defrosting mode allows the heat pump to maintain high system efficiency and energy saving.

Automatic mode

2.2 Operation steps:

Step 1: Confirm whether the LCD screen is unlocked “

Step 2: In the locked state, press and hold the key  for 3 seconds to change from the locked state to the unlocked state. At this time, pressing other keys is effective;

Step 3: Press and hold the key  for 3 seconds to select different modes, the sequence is “  Energy-saving heating mode” “  Powerful heating mode” “ Cooling mode”.

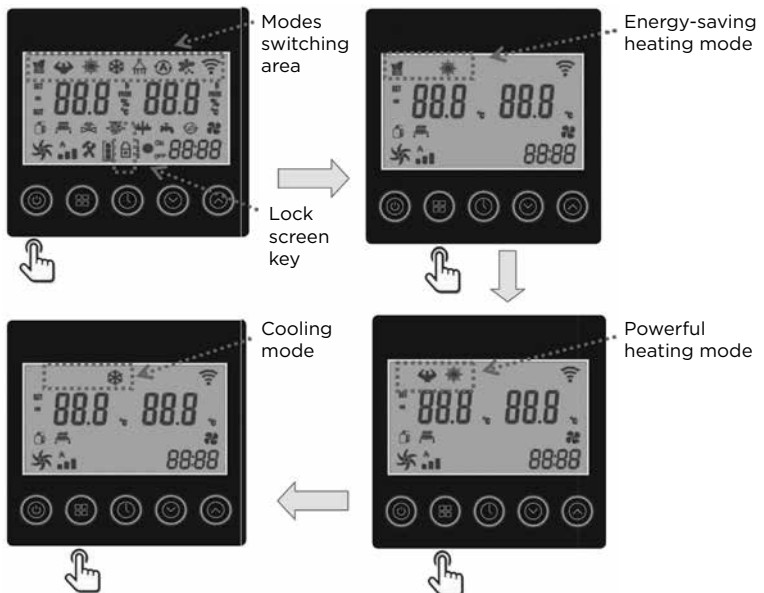



3. Main device operation display



Operation of main components

3.1 Icon definition

 Compressor change operating icon

 Electric heating operating icon

 Water pump operating icon

 Four way valve operating icon

 Water inlet temperature icon

 Fan operating icon

Real-time water inlet temperature display



Real-time water out temperature display

4. Timing on/off setting

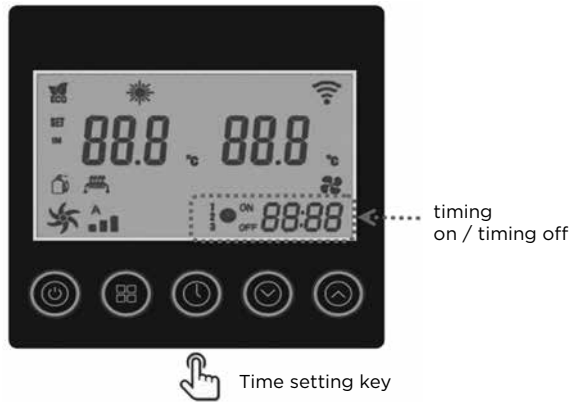

4.1 Icon definition

1 : Split timer icon
2
3

⏻^{ON}
⏪_{OFF} Timer switch icon

88:88 Time icon

4.2 Time setting operation steps:

Step 1: In the main screen, press the “⌚” key until the “hour” digit of the time icon of “88:88” is flashing on the screen. Press the “⏻” or “⏪” to choose the hour required.

Step 2: After setting the “hour” press “⌚” once to confirm;

Step 3: After the hours have been confirmed, the “88:88” “minute” digit of the time bar flashing on the display, press the “⏻” or “⏪” key to select required the “Minutes”

Step 4: After setting the “minute” press “⌚” once to confirm; At this time, the time setting operation has been completed and the setting interface is exited.

For example: set the clock to 23:28, do as follows.

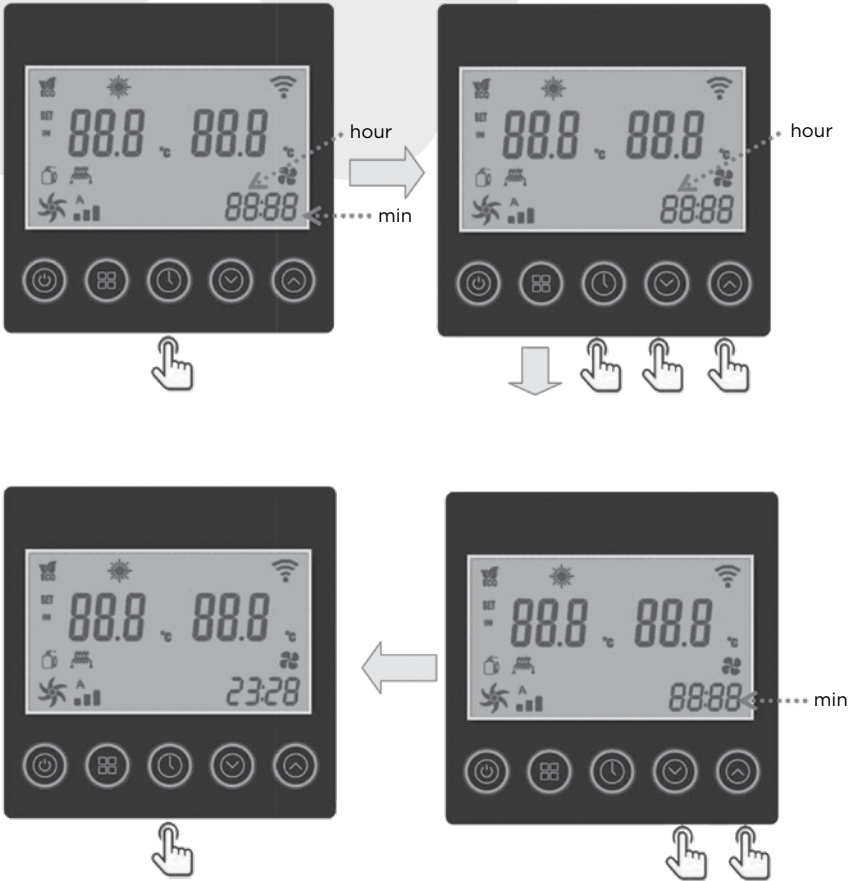

4.3 Setting a timer

Step 1: To Set the first group of timing on/off settings, press and hold the “⌚” button for more than 3 seconds, the “1 ⌚ ON 88:88” display is lit, means the first group of timing power-on settings have been selected;

Step 2: Press the “⏴” or “⏵” key to select the “hour” digit required, and then press “⌚” once to indicate the “hour” digit set has been confirmed;

Step 3: the “minute” digit in the time column of “88:88” will be flashing, press the “⏴” or “⏵” key to select the desired setting. After pressing “⌚” once, it will automatically enter the timing shutdown setting operation;

Step 4: To Enter the timing shutdown setting operation, the “1 ⌚ ON 88:88” display brighten, press the “⏴” or “⏵” key, select the desired “hour” digits and then press “⌚” once to indicate it has been confirmed set the “hour” position and enter the “minute” position setting time at the same time. At this time, you will see the “minute” in the time column of “88:88” will be flashing on the display, press the “⏴” or “⏵” to select the number of “minutes” to be set. After setting the first group time, press the “⏻” key to confirm and return to the main interface.

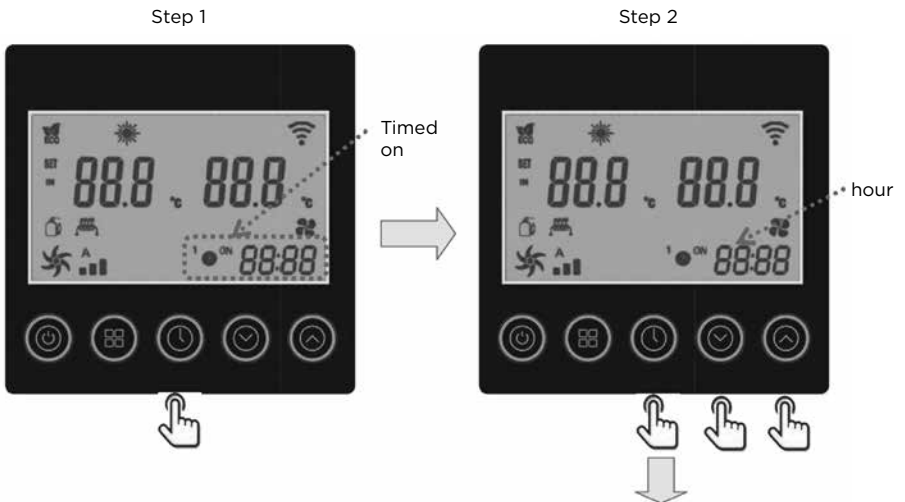



Step 1

Step 2



min



4.4 Segment timing operation steps



Setting the second and third groups of timing on/off: When entering the first group of time,  press the “  ” key once to enter the second group of time settings, 2  ON **88:88** ” will be displayed, use the same operation as setting the first group of timing on/off” (refer to 4.3) to set the second and third group timers.

Step 4



5 View function

Function 1: Press “” or “” key to turn pages and browse related parameters;

Function 2: In the main interface of the power-on state, press the “” or “” key to set the set temperature value in the current mode; after the setting is completed, press the “” key to confirm and return to the main interface.

Function 1



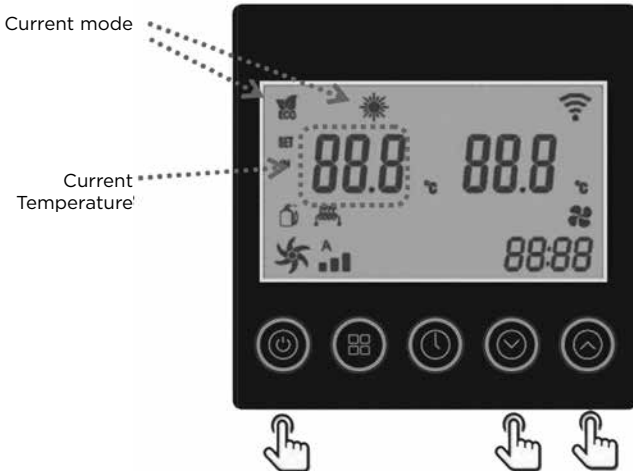

Function 2







6 Parameter setting function

6.1.1 Five-key remote control settings



WARNING: The parameter settings, provided for professional after-sales maintenance personnel. Any setting parameter changes resulting in machine failure or damage is not covered under warranty.



Step 1: Long press the 3S power button “” + “” once to enter the system P parameter setting (can be set in the off state);



Step 2: Press “” or “” to turn pages to query parameters, and then long press the 3S power button “” to select the parameter value;

Step 3: Combine “” or “” to modify the parameter value





Step 4: Then long press the 3S power button “” to confirm, press the on/off button to return to the main interface; if there is no operation for 60s in the parameter setting interface, it will automatically exit and return to the main interface.



Function 1: Long press the mode key  + up key  for 3 seconds to enter the S parameter setting, (repeat steps 1-4).



Function 2: Long press the timer key  + the up  key for 3 seconds to enter the F parameter setting, (repeat steps 1-4).

Function 3: Manual defrost: long press the mode key  +  down key for 3 seconds.

Function 4: Mode switching: long press the timer button  for 3 seconds to proceed.

Function 5: Restore factory settings: Long press the mode key  + timer key  + up key  + down key  for 5 seconds.

Function 6: Switch the light board display: long press the up key  + down key  for 3 seconds.

Function 7: Wi-Fi network configuration: Long press the switch button , the up key  + the down key  for 3 seconds.

Function 1



Function 2



MAINTENANCE OF YOUR POOL HEAT PUMP

Waterco pool heat pumps have been specifically engineered to give you years of satisfaction and enjoyment in the pool.

Cabinet Cleaning

To clean the plastic and painted surfaces use mild soapy water and a soft clean cloth. Never use solvents or abrasives.

Cleaning Evaporator

The evaporator at the rear of the unit must be kept clean and un-obstructed in order for your pool heat pump to have better efficiency and avoid problems which may void your warranty. The dirt collected in the evaporator can be removed with a gentle water spray and the use of a soft brush. Be careful not to damage the aluminum fins.

Cleaning drainage holes

The condensate drainage holes in the base of the unit must be kept free of debris. Blocked drainage holes may cause water to collect in the unit and become stagnant or, interfere with electrical components and wiring.

Issues caused by blocked drainage holes in the base of the unit are not covered under warranty.

Units Located In Coastal Locations

Care and maintenance procedures for Waterco Pool Heat Pumps installed in coastal locations.

Exposure to salt may result in evaporator coil damage shortening the life of the equipment.

Electroheat ECO-V pool heat pumps are fitted with evaporators treated with hydrophilic blue fin technology. The advantages are:

The epoxy coating on the coils prevents accumulation of salt, acid, dust and water deposits which minimises the effects of corrosion.

Hydrophilic blue fin condensers do not allow water droplets to accumulate which can increase the efficiency of the pool heat pump.

Pool heat pumps located within 1 kilometre from the coast should be given a monthly rinse with potable water straight from the garden hose connected to the municipal water system to remove the salt build up on the evaporator coil and exposed metal surfaces.

Winterising Procedure

VITAL

If the pool heat pump is stored in a place where the temperature drops below the freezing point of 0°C / 32°F; it is **mandatory that the water accumulated in the pool heat pump be drained completely before freezing weather prevails. Improper winterizing may damage the pool heat pump and will void the warranty.**

- Turn the pool heat pump **“OFF”**.
- Turn the pool heat pump breaker **“OFF”**.
- The water piping **MUST** be disconnected to drain the pool heat pump’s heat exchanger in preparation for winter.
- Once the piping is disconnected, the pool heat pump’s heat exchanger **MUST** be emptied; the use of a water vacuum cleaner is strongly recommended or if you do not have this tool you may tilt the unit (75°) until all the water is out.
- It is recommended that pool heat pump’s heat exchanger is rinsed out with a gentle water spray at the inlet and outlet water connections of the pool heat pump and then drain the heat exchanger again.
- With the help of 2 pool return winter plugs, block the water Inlet and Outlet connections to prevent access by vermin.
- Clean the drainage holes located at the bottom of the base of the unit.
- Unit may be covered for the winter.
- It is also possible to fill the heat exchanger with pool anti-freeze, but ensure that the antifreeze contains an elevated pH to prevent corrosion. This is optional and requires appropriate hardware.

GENERAL SAFETY INSTRUCTIONS

DO NOT DEPRIVE YOUR POOL HEAT PUMP OF WATER FLOW FOR MORE THAN 24 HOURS WITHOUT DRAINING IT. Make sure you leave the bypass valves as shown in Figure 1.

At the end of each season, when the pool heat pump is no longer in use, and proper pool water chemistry is not maintained, it should be disconnected from the water line and drained to prevent any possible corrosion or damage to the pool heat pump. Refer to Figure 1 below or winterising procedure (page 24).

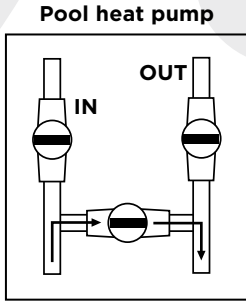

When your valves position are as shown on Figure 1, the water is bypassing the pool heat pump.

Figure 1

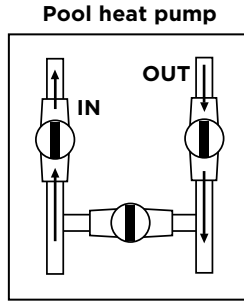

When your valves position are as shown on Figure 2, the water is going through the pool heat pump.

Figure 2

The valves shown above may be different to the ones installed on your system. Please ensure you understand how your bypass valve operates.

TROUBLESHOOTING

Please ensure the unit and any related equipment is installed in accordance with the installation manual. If not, the Waterco warranty will not apply and the customer may be liable for service call charges.

Nothing Is Working And The Electronic Control Does Not Operate

1. Ensure the circuit-breaker has not tripped and/or the fuses have not blown;
****Take note that only an electrician can verify if the circuit breaker is defective; if this is the case, repairs will not be covered under the warranty.**
2. For three phase models, this situation could occur when phases are not in the appropriate order.

Please have a qualified electrician swap over two of the incoming phase wires.

Nothing Is Working But The Electronic Control Temperature Displays Digits Or A Code

1. Identify the analyser code that the electronic control displays and refer to the Service Analyser codes section;
2. If the electronic control displays digits, make sure that the electronic control is programmed correctly, refer to the Operation of your pool heat pump and reprogram if necessary.

***Note that this situation could occur when the electrical voltage is not respected as stated on the pool heat pump name plate. This situation is not covered by the manufacturer warranty.*

Fan Doesn't Work (the fan blades are not moving)

1. IMPORTANT: For safety, switch OFF the circuit-breaker.
2. Try to rotate the fan blades of the fan with a rod to see if the motor is jammed or seized
3. If the fan blades do not turn freely leave the unit switched OFF and call for service;
4. If the fan blades turn freely switch ON the circuit breaker and the pool heat pump again.

*** Note that your fan motor may have an electrical fault if the blades turn freely when the unit is switched OFF and does not start when the unit is switched ON.*

Fan Blades Turn, But Compressor Is Not Functioning

The pool heat pump has a built in delay timer which prevents the compressor from starting immediately. The delay can be 3 to 5 minutes in duration after the fan blades have turned. Furthermore if the unit is in defrost mode the compressor will not start for 3 to 20 minutes.

1. Check that air being discharged from the fan blades is colder than the ambient air. If the air being discharged by the fan blades is colder, it means that the compressor is functioning correctly.
2. Turn off the pool heat pump then immediately turn it back on;
3. As soon as the fan blades start turning, wait a minimum of 3-5 minutes. The compressor should start up after this time and you will be able to identify a different sound made by the compressor when it starts;
4. If the compressor is functioning, but shuts off immediately, consult the following section "Compressor Starts and Stops".
5. If the problem persists, call your local Waterco office for assistance.

Compressor Starts And Stops

1. Check that the unit has been installed correctly (refer to installation procedures).
2. Check that the water inlet and outlet of the unit have not been connected incorrectly.

There Is Water Around The Pool Heat Pump

It is a normal occurrence for water condensation, to be seen running from the unit base. There will be on average 4 to 6 litres of condensed water per hour being discharged from the unit base. In order to avoid water accumulation, you may use decorative rocks around the concrete slab or a basin under the unit. Be sure that clearances around the unit are respected.

To test the unit and confirm you have no pool water leaking from the unit perform the following test which is best performed early in the morning and continuing for the whole day:

1. Turn off the pool heat pump from the circuit breaker and the pool pump.
2. Open the bypass valve. (refer to drawing on page 5)
3. Close the **IN** and **OUT** water valves on the unit.
4. Restart the pool pump. The pool heat pump must remain **OFF**.
5. When all of the water around the base of the pool heat pump has dried, open the water **IN** and water **OUT** valves on the pool heat pump.
6. Close the bypass valve to allow full water flow through the pool heat pump.

If water is now seen running from the outside of the pool heat pump or inside the pool heat pump after a short period of time you should call for service. If no water is seen after a short period of time it would be assumed the water was condensation which is normal.

Pool Heat Pump Has Ice Formed On The Evaporator Coil

1. **IMPORTANT:** For safety, switch OFF the circuit-breaker.
2. Allow the ice to melt and then inspect the evaporator to ensure it is free of debris and leaves.
3. If the evaporator is dusty or dirty, clean it with a light spray of water and allow it to dry (do not use high pressure it may damage the evaporator fins).
4. When the unit is dry, you may switch it back ON from the circuit breaker.
5. Ensure that the clearances around the unit are respected.
6. When the unit has been switched ON ensure the fan motor is working (fan blades will be turning) while the compressor is operating.
7. If the fan blade does not turn and the compressor is functioning; notify customer service.

***If the pool heat pump requires service, the owner of the pool heat pump will need to ensure the unit has been switched OFF to allow any ice to melt prior to any technician attending.*

Pool Heat Pump Is Functioning, But Does Not Reach The Desired Temperature Setting

IMPORTANT

Improper installation may cause this situation and will need to be corrected by the owner.

1. Ensure the by-pass valves are in the correct positions to ensure sufficient water flow, insufficient water flow will cause the compressor to shut off early.
2. If you have installed a timer or the pool heat pump is equipped with an integrated timer, be sure it is programmed to allow the pool pump to work for sufficient time in order to reach the programmed temperature.
3. Ensure the evaporator is cleaned regularly with a light spray of water and allowed to dry before re-starting the pool heat pump to avoid premature ice build up on the evaporator.
4. Waterco recommend the use of a solar cover to retain heat in pool water. Pools without covers lose 2 to 3 times more heat than pools with solar covers.
5. Make sure the electronic control of your pool heat pump has been programmed correctly; during this test the pool heat pump and water pump must be working continuously (eg; the desired water temperature must be set correctly).
6. If the unit continually fails to reach the desired water temperature, we suggest completing the following analysis chart and forwarding it to Waterco in order to avoid unnecessary service fees.

Circuit Breaker Trips

IMPORTANT

If you have purchased a remote control (or other equipment), ensure the equipment is correctly installed. If an operational issue originates from incorrect operation or installation of this equipment, Waterco's warranty will not apply and you will have to pay the cost of the service call.

1. The amperage of the circuit breaker AND the electrical wiring must be as the instructions on the pool heat pump name plate, otherwise notify your installer or electrician to correct this problem, as this is not covered under the warranty.
2. If the circuit breaker and electrical wiring are as stated, make sure the drains, located under the base of the pool heat pump are not obstructed.

The Pool Heat Pump Is Noisy

1. Check the pool heat pump is level and on a solid base to prevent any vibrations issues.
2. Ensure the noise is coming from the pool heat pump, not from other equipment which will not be covered by the warranty (for example: noise coming from the bypass valve, pool pump, etc);
3. An improper installation may cause this situation it will need to be corrected by the owner.

The Temperature Shown On Pool Heat Pump Is Not The Same That Is Shown By The Pool Thermometer

It is possible to have a temperature variation between the temperature shown on the electronic control temperature display of the pool heat pump and a pool thermometer which may be read from different locations.

- Check that there are no leaks on the pool plumbing (there should be no air leaks in the pipework);

Dimensional drawing of heat pump

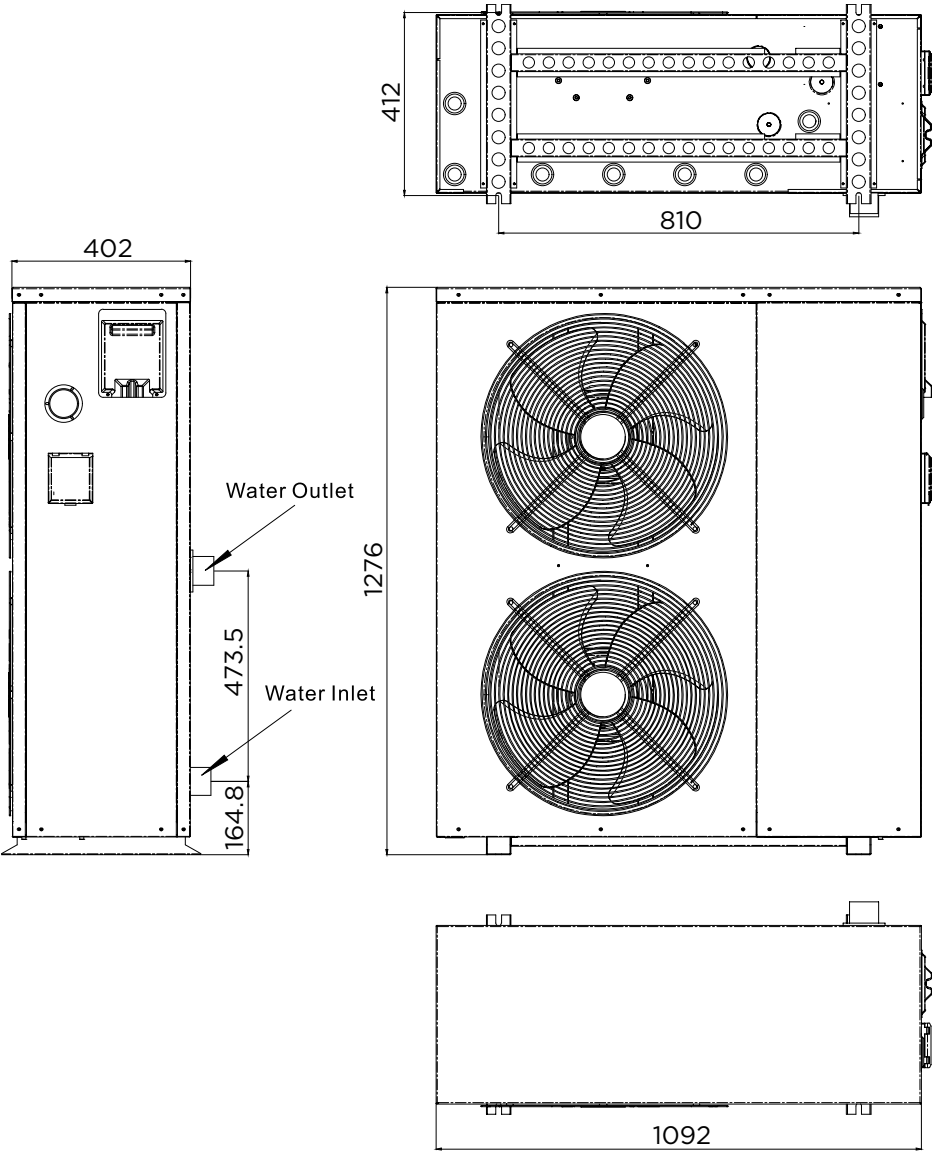

Electric Circuit Drawing

Electroheat ECO - V 25kW

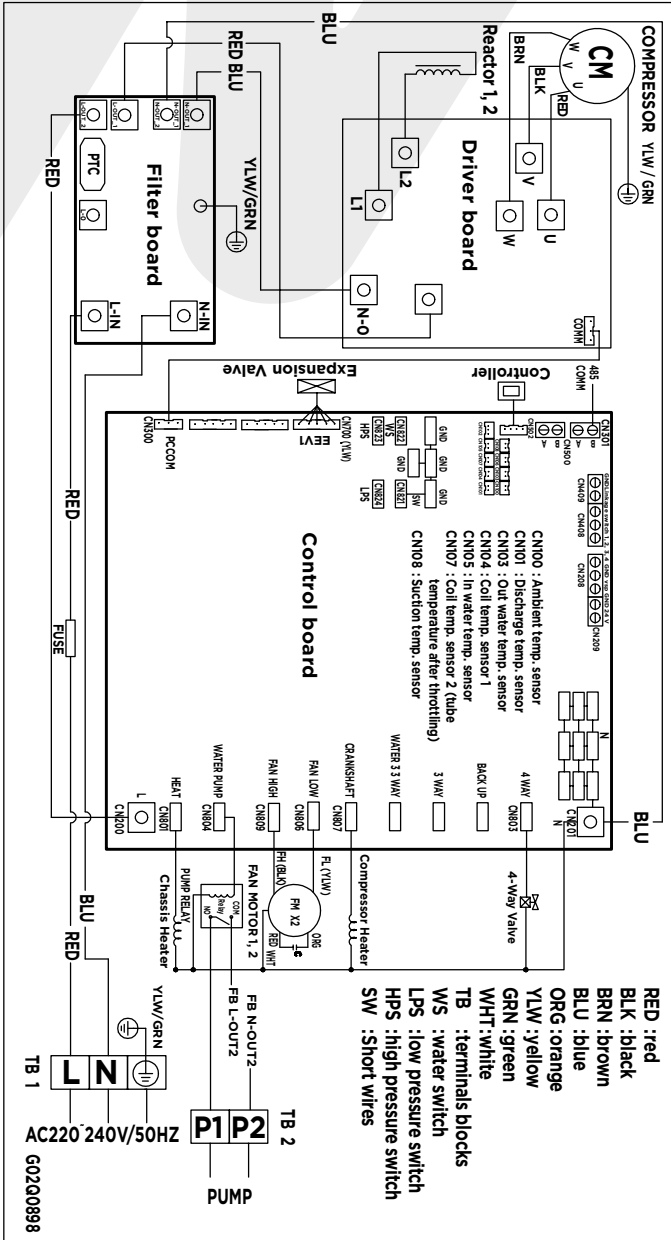

Service Parameters Tables

Error code table



Code	Description
E03	Flow failure
E04	Anti-freeze protection
E05	High pressure protection
E06	Low pressure protection
E09	Connection failure between control mainProgram board and controller
E10	Connection failure between driver and mainProgram board
E11	After throttle temp sensor failure
E12	Exhaust temperature over
E15	Water inlet sensor failure
E16	Outside coil sensor failure
E18	Exhaust sensor failure
E20	Driver module protection
E21	Ambient temperature failure
E22	Vast temperature variations between inlet and outlet
E23	Water outlet temperature lower in Cooling Mode
E27	Water outlet sensor failure
E29	Suction pipe sensor failure
E30	Protection against low outdoor ambient temperature
E31	Overload protection of auxiliary electric heating
E32	Water outlet temperature over in Heat Mode
E33	Outside coil temperature over in Cooling Mode
E34	Compressor drive failure
E35	Compressor current over
E36	Compressor output failure
E37	IPM current failure
E38	Heat sink temperature too high
E39	Power overload shutdown (PFC failure)
E40	DC voltage over
E41	DC voltage lower
E42	Inside coil sensor failure
E43	AC voltage lower
E44	AC current over
E45	Driver E2 failure
E46	DC FAN failure
E47	AC voltage over

Parameter table

Tap the mode key  to enter.

Code	Description	Scope	Unit	
c01	Ambient Temperature		0.1° C	
c02	Outer coil		0.1° C	
c03	Exhaust gas temperature		0.1° C	
c04	Suction temperature		0.1° C	
c05	Reserved		0.1° C	
c06	Reserved		0.1° C	
c07	Inner coil temperature (after throttling)		0.1° C	
c08	Inlet water temperature		0.1° C	
c09	Outlet water temperature		0.1° C	
c10	Reserved			
c11	Reserved			
c12	Reserved			
c13	Sensor fault bit			
c14	System fault bit			
c15	Drive failure bit			
c16	Device output bit			
c17	Running status bit			
c18	AC voltage		V	
c19	DC voltage		V	
c20	Actual frequency		Hz	
c21	Main valve opening			
c22	Reserved			
c23	Whole machine current		A	
c23	Press current		A	

Parameter Setting

Long press the power button  + up key  for 3 seconds to enter.

Code	Description	Default	Scope	Remark
P01	Heating return water temperature setting	45°C	0 ~ 60°C	
P02	Refrigeration return water temperature setting	12°C	7 ~ 35°C	
P03	Reserved	45°C		
P04	Starting temperature difference	5°C	1 ~ 10°C	
P05	Choice of ON/OFF or constant temperature	0	0 or 1	
P06	Fast commodity inspection mode	-17°C	2 ~ -30°C	Only applicable to special remote controlle
P07	Electric heating forced start temperature	-15°C	-30 ~ -30°C	
P08	Electric heating start offset time	5 min	0 - 10min	
P09	Select the set temperature mode according to the outdoor environment	0	Reserved	
P10	Change the return water temperature origin value	36	Reserved	

Function setting

Long press the mode key  + up key  for 3 seconds to enter.

Code	Type	Defaults	Settable range	Remarks
S01	Reserved	1	0-1	
S02	Model selection	2	0 single cold, 1 cold and warm, 2 single hot	
S03	Reserved	1	1-6 Reserved	
S04	Defrost mode	0	0/1 Reserved	
S05	Defrost into temperature setting	-4 °C	0 - -30 °C	
S06	Defrost exit temperature setting	15 °C	2 - 20 °C	
S07	Defrost interval	40min	25-200min	
S08	Defrost process time	12min	2 - 20min	
S09	Difference between defrost coil and external environment	6 °C	0 - 10 °C	
S10	Water pump operation mode selection	0	0 long open; 1 cycle; 2 to warm stop	
S11	Initial opening of auxiliary valve	80	0 - 520	
S12	Fixed frequency operation	0	0 automatic operation; 1 fixed frequency operation	
S13	Fixed frequency frequency setting	60	0 - 120HZ	
S14	Enthalpy valve opening ambient temperature	7 °C	0 - 15 °C	
S15	Main valve electronic expansion valve adjustment	0	0 automatic operation; 1 fixed pulse operation	
S16	Main electronic expansion valve pulse opening setting	120	0 - 520	

S17	Auxiliary valve electronic expansion valve adjustment	0	0 automatic operation; 1 fixed pulse operation	
S18	Auxiliary electronic expansion valve pulse opening setting	60	0 - 520	
S19	Main valve superheat adjustment value	2 °C	-10 - 20 °C adjustable operation	
S20	Enhancement function selection	0	0 Not equipped 1 Optional	
S21	Electronic expansion valve adjustment cycle	30S	10 - 240S	
S22	Linkage selection	1	0 Not equipped 1 Optional	
S23	Defrosting main valve opening	450	0 - 520	
S24	Minimum value of expansion valve exhaust	65 °C	20 - 110 °C	
S25	Fuzzy defrosting ring temperature > 4 °C entering disc temperature	-6 °C	-30 - 150 °C	
S26	Fuzzy defrosting ring temperature ≤ 4 °C entering disc temperature	-10 °C	-30 - 150 °C	
S27	Fan type selection	0	0 Two-speed AC fan; 1 DC fan; 2 Single speed AC fan	
S28	Electric heating switch control	1	0(turn off) / 1(turn on)	
S29	Condensing electric heating switch control	1	0(turn off) / 1(turn on)	
S30	Protection value of excessive temperature difference between inlet and outlet water	13 °C	5 - 20 °C adjustable	

WARRANTY

If a defect occurs in any Waterco product during the warranty period, Waterco will at its discretion, repair the product or replace and install the defective part, free of charge provided that the defect results solely from poor workmanship or materials and subject to these terms and conditions.

Labour is covered by this warranty for a period of 12 months from the date of purchase or installation, within a 25 km (15 miles) radius of an authorised Waterco Service Agent.

The purchaser is responsible for any freight incurred.

Warranties are valid only within the original country of purchase. Our goods come with guarantees that cannot be excluded under the region's Consumer Law. You are entitled to a replacement or refund for a major failure and compensation for any other reasonably foreseeable loss or damage.

You are also entitled to have the goods repaired or replaced if goods fail to be of acceptable quality and the failure does not amount to a major failure.

Visit www.waterco.com.au/customer-service/warranty-terms for our full Warranty Terms and Conditions.

NOTE

OFFICES - AUSTRALIA

NSW - SYDNEY
(HEAD OFFICE)
Tel : +61 2 9898 8600

VIC/TAS - MELBOURNE
Tel : +61 3 9764 1211

WA - PERTH
Tel : +61 8 9273 1900

QLD - BRISBANE
Tel : +61 7 3299 9900

SA/NT - ADELAIDE
Tel : +61 8 8244 6000

ACT DISTRIBUTOR
Tel : +61 2 6280 6476

OFFICES - OVERSEAS

WATERCO (EUROPE) LIMITED
Sittingbourne, Kent, UK
Tel : +44 (0) 1795 521 733

WATERCO USA
Augusta, USA
Tel : +1 706 793 7291

WATERCO CANADA
Boucherville, Quebec, Canada
Tel : +1 450 748 1421

WATERCO (NZ) LIMITED
Auckland, New Zealand
Tel : +64 9 525 7570

WATERCO (C) LIMITED
Guangzhou, China
Tel : +8620 3222 2180

WATERCO (FAR EAST) SDN BHD
Selangor, Malaysia
Tel : +60 3 6145 6000

PT WATERCO INDONESIA
Jakarta, Indonesia
Tel : +62 21 4585 1481

WATERCO SINGAPORE INTL PTE LTD
Nehsons Building, Singapore
Tel : +65 6344 2378

www.waterco.com.au

This web site address will enable you to select the appropriate country website.

WATERCO

Waterco Limited ABN 62 002 070 733

